



Technical Catalogue

Table of contents

Selection diagram for sizes 64–3125	3
Fresh air made to measure	4
Optimised frame design	5
Guidance for a perfect use for this document	6
Number of filter cells for sizes 64–3125	7

PRODUCT DESCRIPTIONS

Housing connections	8
Canvas connector (STS)	8
Air-control damper external/internal (JKL)	8
Weather guard (WSG)	8
Decoupled adapter (EKS)	8
U-frame (URA)	8
Counter-frame (GGR)	9
Air intake/outlet hood (ASH)	9
Air intake and outlet systems	9
Front panel (SW)	9
Intake part (A)	9
Outlet part (A)	9
Mixing part (M)	9
Double mixing part (MM)	9
Filters	10
Cassette filter (KF)	10
Bag filter (TF)	10
Absolute filter (AF)	10
Activated carbon filter (AKF)	10
Electrostatic filter (ESF)	10
Heat exchangers	10
Electric heater (EE)	11
Heater (EH)	11
Frost protection frame (FS)	11
Chiller (KH)	11
Demister (TA)	12
Heat recovery systems	12
Plate heat exchanger (PT)	12
Counterflow heat exchanger (GSWT)	13
Run around coil system (KV)	13
Rotary heat exchanger (RT)	14
Humidification systems	14
Steam humidifier (DB)	14
Surface humidifier (OFB)	15
High-pressure humidifier (HDB)	15
Air washer (LW)	15

Fans	15
Fan with belt drive (VR)	15
Impact diffuser (P)	16
Fan with free-running impeller (VF)	16
Silencers	16
Silencer (SD)	17
Empty sections	17
Empty section (L)	17
TECHNICAL DETAILS	
Housing connections	18 — 19
Air intake and outlet systems	20 — 21
Filters	22 — 23
Heat exchangers	24 — 25
Heat recovery systems	26 — 31
Humidification systems	32 — 33
Fans	34 — 35
Silencers & empty sections	36 — 37
Door locking systems	38 — 39
Base frames and feet	40 — 41
Multi leaf dampers	42 — 43
Weatherproof executions	44 — 45
Wall and ceiling fixtures	46
Quality	47
Compact units	48 — 49
Sairios, Diamant, Goliath, Goliath Top 4, Aquawell	
Special components	50 — 51
Maintenance platform with stairs, folding maintenance platform, Accubloc, indirect firing, direct firing	
Special applications	52 — 55
Units for test benches, units for greenhouses, units made in plastic, Units of customised dimensions and shapes, units for high external pressure, high-temperature units, hall ventilation units, GFRP units, unit-inside-unit systems, antimicrobial coating, fuel gas extraction systems for aeroplanes	
Software	56 — 57
Mollier h-x diagram	58
Transport & lifting devices	59

Selection diagram for sizes 64–3125

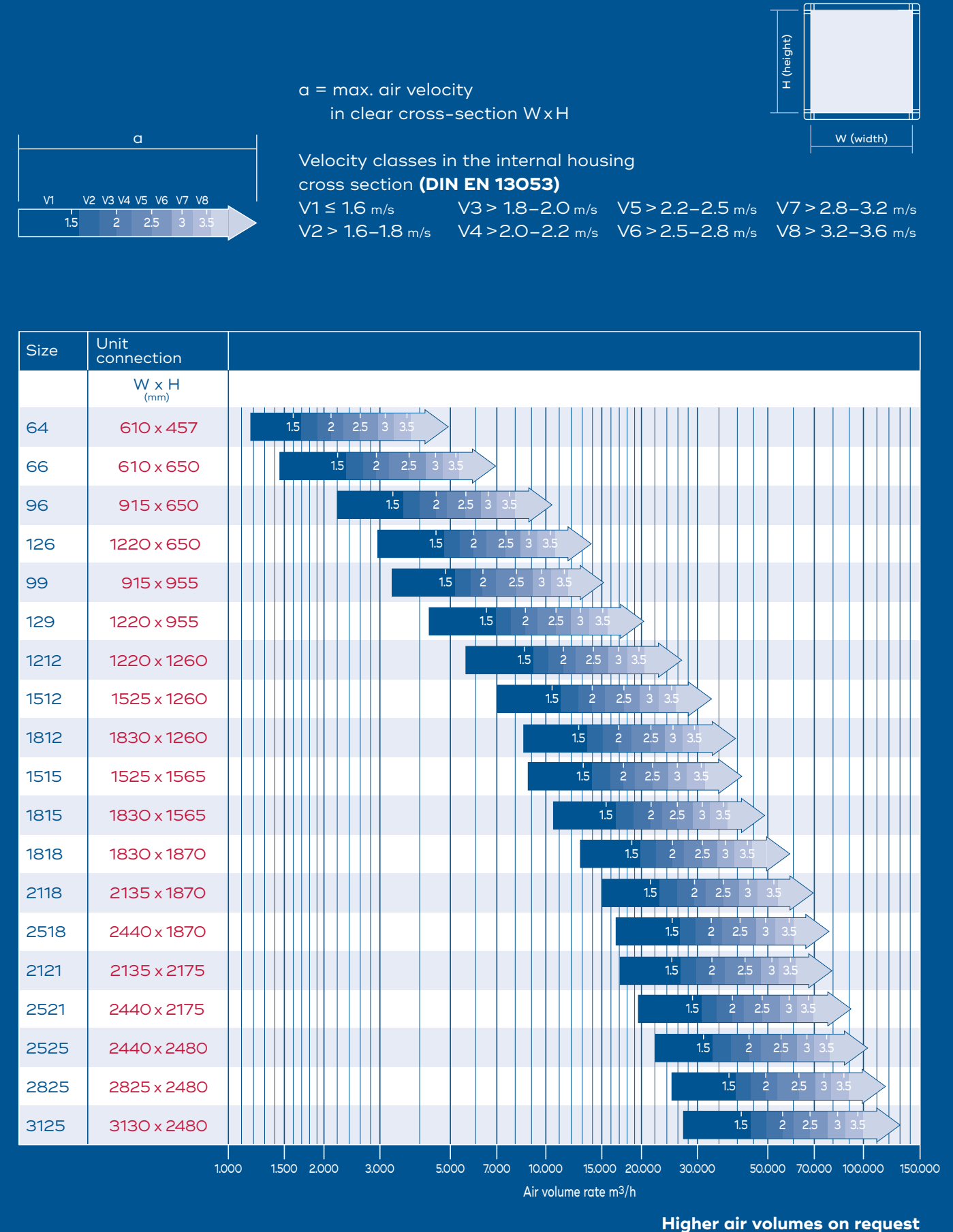

Fresh air made to measure

Shopping centres and offshore platforms, hospitals and food processing plants – these and many more facilities have very specific requirements when it comes to air and climate control. Our experts develop tailor-made solutions and units for all air handling purposes and requirements – from thermal comfort, hygiene, drying and dedusting to detoxifying, sound insulation and energy recovery. Our expertise is par-

ticularly in demand when it comes to sterile air handling in operating theatres. We know exactly what the market needs, and our compact units of the Diamant, Goliath, Goliath Top 4 and Sairios series have long become best-sellers. Whether you are looking for a turnkey unit or a custom-engineered AHU – you can rely on our exceptional know-how and experience gained over many years in the business.

**Complex tasks.
Industry-specific solutions.
Perfect implementation.**

- POOL & SPA
- OFFICES & EDUCATION FACILITIES
- HEALTHCARE INSTITUTION
- CLEANROOM & PHARMA
- FOOD
- SPORTS
- SHOPPING
- MARINE & OFFSHORE
- MILLS
- INFRA-STRUCTURE
- AGRI-CULTURE
- INDUSTRY
- FAIRS
- HOTEL & GASTRONOMY

Optimised frame design

Our AHU casing frame system consists of profiles and panels, combined with innovative technology that makes all the difference. These intelligent frame systems cater for virtually all design requirements and dimensions, feature a unique screwless and rivetless clamping strip system and combine top-grade materials with exceptional craftsmanship.

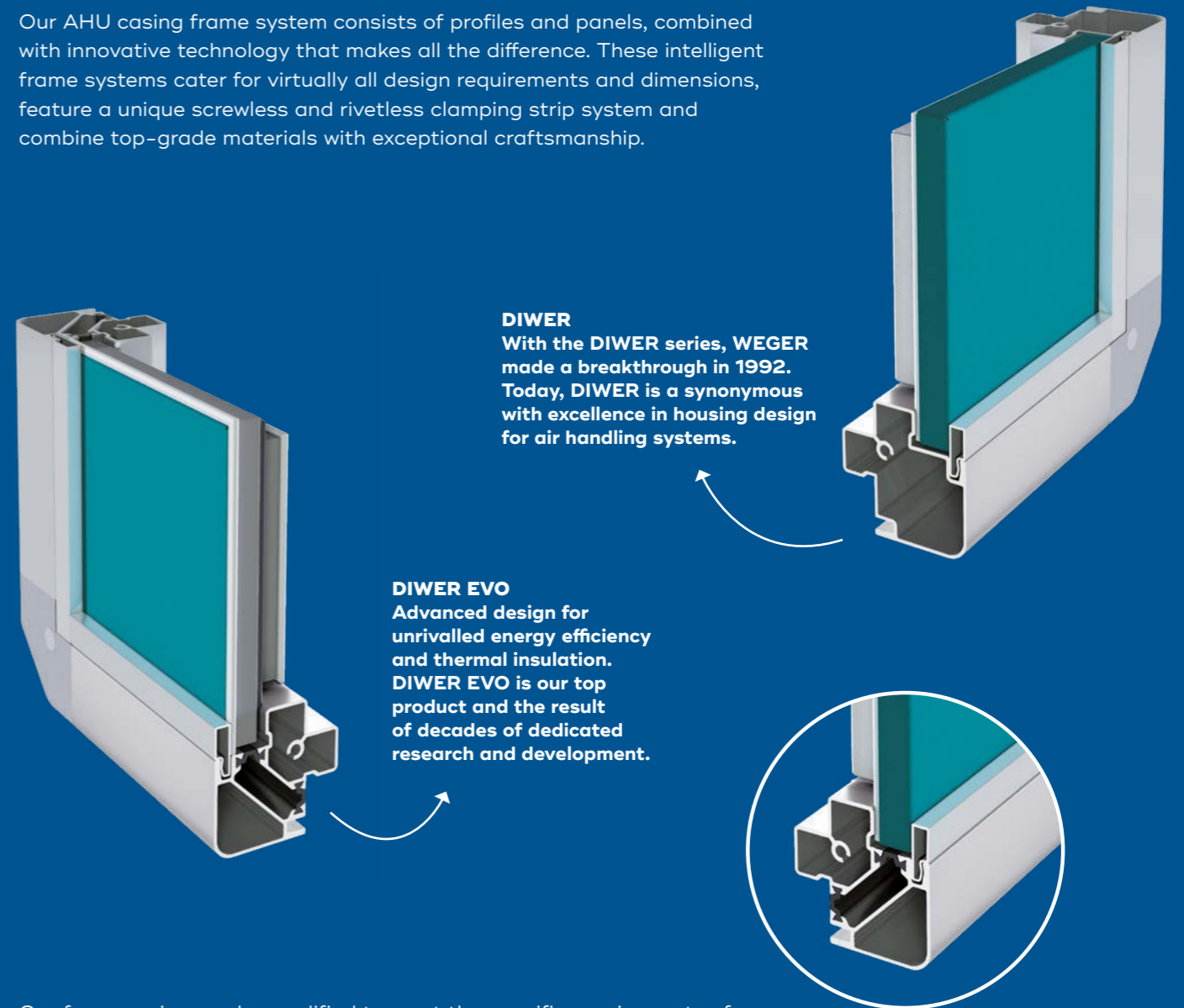

DIWER
With the DIWER series, WEGER made a breakthrough in 1992. Today, DIWER is a synonymous with excellence in housing design for air handling systems.

DIWER EVO
Advanced design for unrivalled energy efficiency and thermal insulation. DIWER EVO is our top product and the result of decades of dedicated research and development.

DIWER TE
Cost-efficient hybrid solution combining the best features of the classic DIWER design and the DIWER EVO best-seller.

Our frame series can be modified to meet the specific requirements of any application. It goes without saying that our products meet all relevant international standards and come with the necessary certificates. Our three standard frame models can be combined as required. Each series is available in versions HG (hygiene) and WF (weatherproof, for outdoor installation). The models of the DIWER series are also available as ATEX versions for installation in potentially explosive atmospheres.

MODEL BOX DETAILS ACCORDING TO DIN EN 1886 (07/2009)

Series	Thermal insulation	Thermal bridging factor	Leakage	Mechanical strength of casing	Filter bypass leakage
DIWER EVO	T2	TB1	L1	D2	F9
DIWER TE	T2	TB2	L1	D1	F9
DIWER	T3	TB3	L1	D2	F9

Guidance for a perfect use for this document

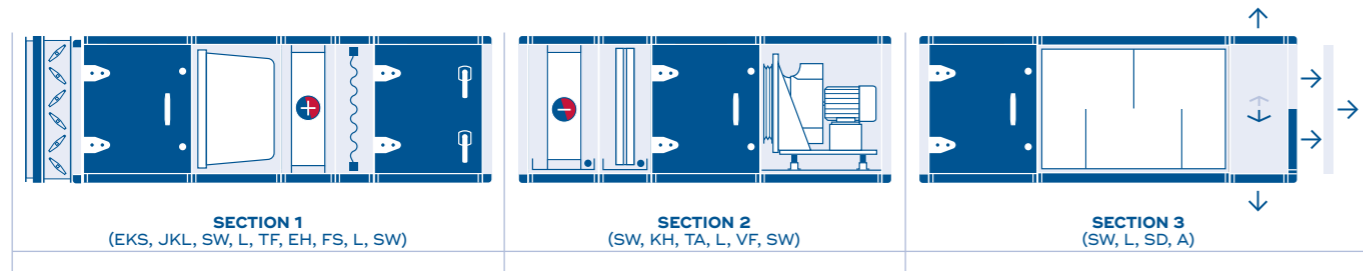

This technical catalogue enables you to design an air handling system that best suits your needs. It could not be easier: Step by step, and page by page, we guide you through the products and models available from WEGER.

Start with determining the size of the system and the number of filter cells you require. The relevant information is printed on the left fold-out of the cover. If you need for instance an air volume of 7,000 m³/h, select this value along the horizontal axis. If you are looking for a high-efficiency system, the air velocity in clear cross-section – expressed in m/s – should be as low as possible. Based on this velocity, EN 13053 defines efficiency classes, whereby V1 and V2 are the lowest classes, while A+ is the highest class according to the RLT Guideline. To configure a device for class A+, trace the vertical line in the diagram at value 7,000 m³/h upwards and you find three possible sizes, namely 129, 1212 and 1512. The relevant clear cross-section is shown to the left. If you choose for instance the middle option of 1212, the clear cross-section is 1220 x 1260 mm (W x H). In section “Number of filters for sizes 64–3125” on the page to the right, look up the size you have chosen, e.g. 1212, and you can see that this size requires four full standard filter cells.

Chapter “Product descriptions” contains detailed information on the available system components. These descriptions are also useful for the drafting of tender documents.

After choosing your components, you will have all the information and technical parameters for the design of the overall system at hand. Based on this information, you can now calculate the lengths and weights of the shipping sections.

In our example, the system will be shipped in three sections. Every section features a frame at each end.

EXAMPLE: VALUES FOR SIZE 1212

Code	Designation	Length (mm)	Weight (kg)	Page
EKS	Decoupled adapter	60	5	18
JKL	Air-control damper, external	130	54	18
SW	Front panel	48	10	20
L	Empty section (maintenance door with square key locks)	457	65	36
TF	Bag filter	458	109	22
EH	Heaters	200	90	24
FS	Frost guard	152	27	24
L	Empty section (maintenance door with locking handle)	457	65	36
SW	Front panel	48	10	20
SECTION 1		2010	435	
SW	Front panel	48	10	20
KH	Chiller	420	165	25
TA	Demister	350	64	25
L	Empty section (maintenance door with square key locks)	457	65	36
VF	Fan with free-running impeller	1136	440	35
SW	Front panel	48	10	20
SECTION 2		2459	754	
SW	Front panel	48	10	20
L	Empty section (maintenance door with square key locks)	457	65	36
SD	Silencer	750	250	37
A	Outlet part	678	95	20
SECTION 3		1933	420	
TOTAL		6402	1609	

These frames are then connected with each other when the system is assembled on site. For more information about safe transport, lifting gear and correct installation, see [page 59](#).

This document also contains detailed information regarding accessories and special models, and includes references to the planning documents for preconfigured compact units that are available separately. The cover fold-out at the back contains a Mollier h-x diagram for detailed planning.

Number of filter cells for sizes 64–3125

The cross-section of an air handling unit must always be chosen on the basis of customer requirements and the actual site conditions. As there are no limits to what we can produce, we can meet virtually any cross-section specifications. In the end, all our systems are custom-engineered. To facilitate the planning and design process, we work with standard filters installed in frames inside the units. We have devised 19 basic configurations that have been proven to be the most effective combinations. However, there are no limitations as regards possible device combinations and layouts!

Each standard filter of dimensions 610 x 610 mm (W x H) constitutes a full cell, which is integrated into a frame inside the unit. The first two digits of the cell width and height are combined to indicate the size. For the above standard filter, this would be 66. Size 1818 thus consists of 3 x 3 filter cells. Size 129 is 2 cells wide and 1.5 cells high. If necessary, cells can be divided even further in order to meet your specific requirements. In each combination, 40 mm are reserved for internal wiring.

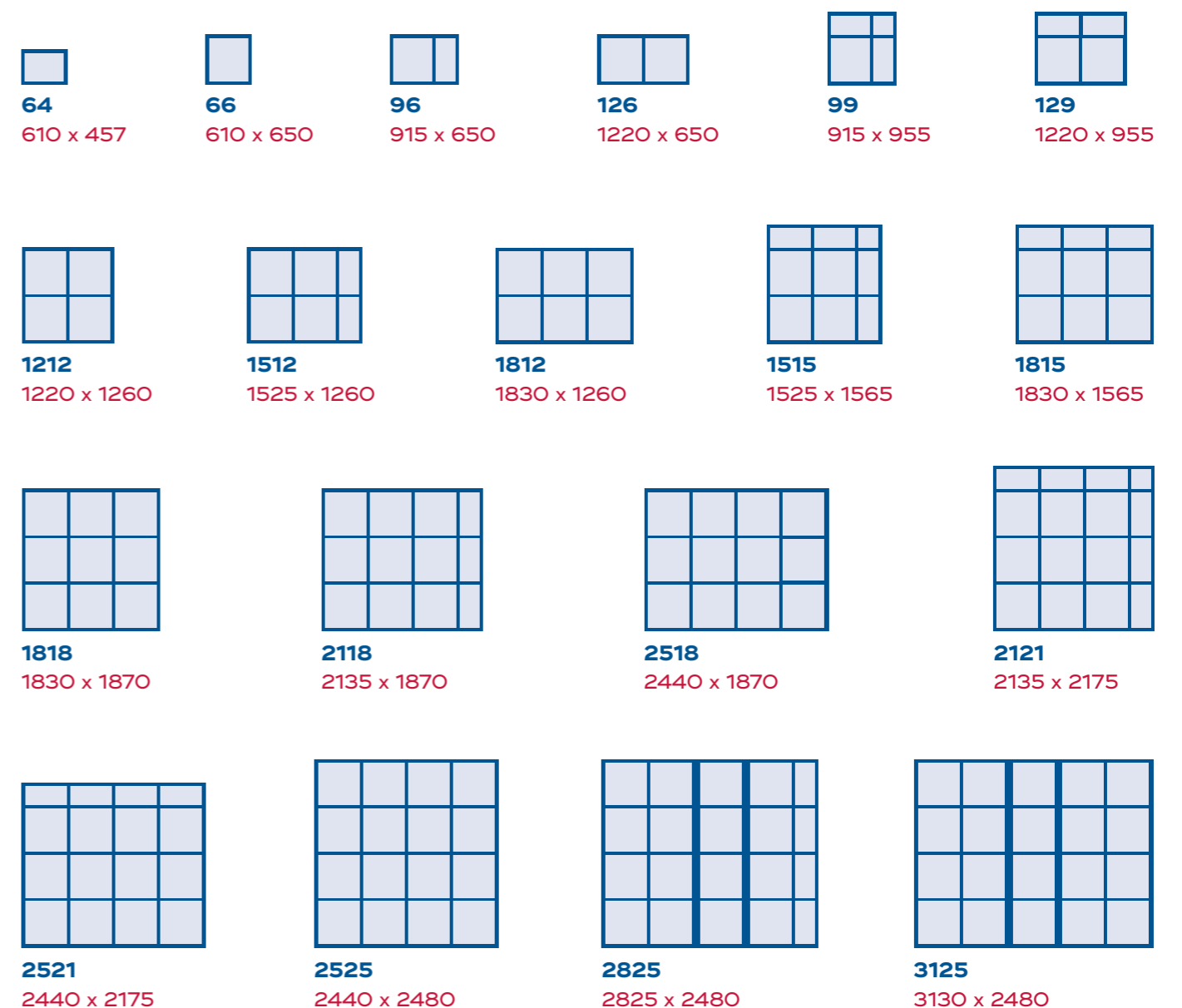

Product descriptions

Housing connections

The housings of the air handling and air-conditioning units from WEGER are based on the successful DIWER series and its variations. These modular frame constructions allows for the extension and upgrading of the units with additional components in all directions. In addition, there are no limitations as regards the connection to the duct and pipeline system on site.

CANVAS CONNECTOR (STS)

The canvas connector is a flexible duct connector for structure-borne noise decoupling and expansion compensation.

The canvas connector consists of:

- Bellows made from special fabric, with air-tight polyester coating on both sides
- Ends fitted with rigid profile frames with rounded edges
- Permanently sealed press fit connectors
- Perforated corners, matching standard air channel profiles
- Galvanised, non-rusting frame
- Circumferential lip seal, embedded in the bead to which the bellows are welded
- Plastic-welded joints

The canvas bellows are permanently flexible, air- and pressure-tight, as well as resistant to tearing, moulding and shrinking.

They conform to EN 13180 tightness class, and their standard temperature resistance is 80 °C. On request, the component is also available with a temperature resistance of up to 160 °C.

AIR-CONTROL DAMPER EXTERNAL/INTERNAL (JKL)

The air-control damper is installed either at the outside of the unit, or inside the unit.

The air-control damper consists of:

- Sturdy aluminium profile frame of 130 mm in depth, with a flange width of 30 mm
- Aluminium louvres consisting of torsion-resistant hollow profiles with lip seals

The louvres are driven by maintenance-free plastic gears and a positioning axis that can be operated

manually or by a servo motor. To prevent deposits on the gears, they are integrated into the frame and thus shielded from the air flow. The fins are borne in lubrication-free plastic bushes. The air-control dampers are available in EN 1751/ DIN 1946 tightness classes 2, 3 or 4. They are temperature-resistant from -20 °C to +80 °C. For detailed information on WEGER air-control dampers, see [pages 42 and 43](#).

WEATHER GUARD (WSG)

The weather guard is a duct that protects the fresh air and exhaust air flows from the elements and keeps out dirt (e.g. fallen leaves) and animals such as birds. The guard is a rectangular component ready for installation and available in any size.

The weather guard consists of:

- Front frame in aluminium, with torsion-resistant aluminium louvres of a special aerodynamic design to reduce pressure loss
- Water-repellent bird guard attached to the rear

Thanks to the aerodynamically designed fins, the pressure differential is kept low, and there is virtually no flow noise. The weather guard features a front frame for easy and quick installation. The clear cross-sectional area is normally 60 %, and around 45 % in guards with insect screen. The guard is free of silicone.

DECOUPLED ADAPTER (EKS)

The decoupled adapter is a flexible air duct connecting frame designed for optimised sound insulation and thermal decoupling.

The decoupled adapter consists of:

- Double profile frame
- Large-pore sponge rubber insulation between the profiles
- Profile frame with a flange width of 30 mm and 4-bore connection

The decoupled adapter is airtight according to DIN EN 16798-3. Its parts can move against each other and are screwed together. It provides full equipotential bonding across both frame sections.

U-FRAME (URA)

The U-frame is a rigid frame for connection to an ventilation channel. It is made from galvanised sheet

steel or stainless steel. The flange measures 30 mm and the hole pattern conforms to DIN 24193 R1. Its corners are welded airtight. The frame meets the requirements of DIN EN 1507 tightness class C.

COUNTER-FRAME (GGR)

The counter-frame is designed for the connection of air channels to length adjustment devices, and for the installation of adapters where one side is not equipped with a flange. Counter-frames are flanged profiles with a high torsional rigidity. They are mounted to unit openings.

AIR INTAKE/OUTLET HOOD (ASH)

The air intake/outlet hood is made of aluminium and includes a bird guard. It is designed for installation in weatherproof outdoor units and prevents water, leaves, dirt or animals entering the system. The clear cross-section is optimised for minimum drag and pressure loss, as well as for low-noise operation.

Air intake and outlet systems

Each unit is designed for optimum distribution of the incoming air and flow to the downstream components. In many models, the cross-sectional area inside the unit is greater than that of the air channel network, which has a calming effect on the air in the intake section.

FRONT PANEL (SW)

The front panel is a section installed at the front end of an element, designed for the connection to air channels or dampers, weather guards or hoods. Given frame design of our units, front panels need to be installed wherever there is an air inlet or outlet. The front panel must be installed at the front of the element. If it features a reduced opening, it must be followed by an empty section.

INTAKE PART (A)

The intake part is a section installed at the front end of the unit and holds the components for the connection of air channels, dampers, weather guards or hoods.

It consists of a front panel (all-side profile frame construction), followed by an empty section for maintenance purposes (and can thus be fitted with a door, a sight glass and lamp).

Five possible positions for openings:

1. At the front end, with an opening as wide as the cross-section, or with an opening of a reduced size, towards the top or bottom
2. At the operating side
3. Opposite the operating side
4. At the top
5. At the bottom

OUTLET PART (A)

The outlet part is a section installed at the rear end of the unit and holds the components for the connection of air channels, dampers, weather guards or hoods. It consists of a front panel (all-side profile frame construction), followed by an empty section for maintenance purposes (and can thus be fitted with a door, a sight glass and lamp).

Five possible positions for openings:

1. At the rear end, with an opening as wide as the cross-section, or with an opening of a reduced size, towards the top or bottom
2. At the operating side
3. Opposite the operating side
4. At the top
5. At the bottom

MIXING PART (M)

The mixing part forms part of the housing and features dampers for the mixing of different air flows. By operating these dampers, fresh air and recirculated air are mixed, for instance to cool or heat the air stream. The positions of the openings can be chosen to suit the actual purpose and design of the unit, i.e. top/bottom or front/rear.

DOUBLE MIXING PART (MM)

This part is similar to the mixing part described above, but features more dampers for more mixing options. The dampers can be used to mix fresh, exhaust and recirculated air, or switch between these flows. This allows for functions such as fresh air operation or free cooling, mixed air operation and recirculated air operation.

Filters

Filters inside an air handling unit are used to improve the air quality by holding back dust and other airborne particles. They also protect the ventilation system against dirt and loss of performance. Filters come in various types and versions and need to be selected in line with the actual requirements. The frame material (head frame) of the filter and the actual filter medium can be chosen separately.

CASSETTE FILTER (KF)

Cassette filters feature a filter cartridge or element that can be regenerated. For this purpose, the cartridge needs to be removed from the unit, which is possible by opening a detachable panel and pulling the filter along a guide rail from the housing. The filter cartridge is made from synthetic fibres and installed in a V-shape inside the cassette. It offers a large filter surface and thus holds back a lot of dust despite its compact design.

BAG FILTER (TF)

Bag filter cartridges consist of:

- Standardised, high-performance bag filters
- In inherently stable shape. available in various lengths from 300 to 750 mm
- Installation frame screwed into the housing (on request, we offer special frames with a quick-release filter clamping mechanism to replace the standard installation frame)
- Filter medium made from fibre glass or synthetic, non-breaking fibres, with a temperature resistance up to 80 °C

Thanks to their innovative design, bag filters have an exceptionally high dust retention capacity. The filter cartridges mounted in the installation frame are equipped with sealing and clamping elements according to DIN 1946 sheet 4 for airtight installation. For operation and maintenance, the filter cartridge can be accessed from the clean air side, and from the dust air side through a separate face element. The classification of the filters is based on DIN EN ISO 16890.

ABSOLUTE FILTER (AF)

Absolute filters offer a high degree of filtration and exceptional efficiency combined with low initial pressure drop and a long service life.

Featuring mini-pleat filters made from micro-glass paper that provide large filter surfaces, absolute filter are commonly in filter classes E10 to U17. On

request, we offer filters with an arrestance according to EN 1822 of 99.97 to 99.99997 %. The filters are equipped with seamless foam PU seals and are mounted airtight in special filter installation frames. These frames come with protected handles at both sides for easy installation and can be fitted with an optional seal test groove. The frames are mounted in the unit with airtight seals. To minimise contamination of the unit during filter change, we recommend incorporating a door in the empty section at the dust air side of the filter.

ACTIVATED CARBON FILTER (AKF)

Here, the filter system is filled with activated carbon granules and consists of a cylinder available in various materials. The activated carbon grade needs to be chosen on the basis of the actual application and the requirements for chemical separation. For easy filter change, we offer elements with a bayonet mechanism as well as combination cassettes in a stainless-steel housing with pleated activated carbon mediums and integrated prefilter. Both options allow for tool-free filter change. The empty section for maintenance access can be installed upstream or downstream of the filter.

ELECTROSTATIC FILTER (ESF)

Electrostatic filters work with electricity to remove solid and liquid contaminants (e.g. oily vapours) from the air flow. They also have great antimicrobial properties.

The filter consists of:

- Electrostatically charged, powered aluminium panels in the form of a cassette
- Special electric supply and control system

Efficiency and pressure loss remain constant during the life time of the filter. The empty section for maintenance access can be installed upstream or downstream of the filter.

Heat exchangers

Heat exchangers transfer thermal energy from one medium or element to another. One medium serves as the heat source, while the other is the heat receiver. As the two mediums flow in completely separate circuits through the heat exchanger, they do not need to be in the same state of aggregation. In most air handling units, the heat source in the heat exchanger is a liquid, while the heat receiver is gaseous. For heat exchangers to work efficiently, it is important that the

wall separating the two mediums transfers heat from one to the other. That is why heat exchangers are made from materials with good heat transfer properties, such as copper or aluminium.

ELECTRIC HEATER (EE)

Electric air heaters are used for the direct heating of air streams. Electric energy from 2 to 2000 kW is thereby converted with virtually no loss into heat. Air heaters are generally installed in the central air handling unit and are widely used in industrial processes as well as in high-load environments.

The standard model consists of a housing made in aluminium-zinc coated sheet steel (AZ 185) and meets the requirements of corrosion protection class C4. We also offer housings in stainless steel. When designing a system, we take into account the wishes of our customers as regards specifications, materials and accessories to suit their specific applications.

The heating rods of the electric heaters, which consist of profiled or smooth tubes made in ST1203, VA 1.4541 or VA 1.4828 steel, meet most specifications and application requirements. Thanks to their large surfaces, high resistance and fibre-free design, they are extremely durable and sustainable.

The terminals for the electrical connections are housed in a terminal box that meets the VDE requirements and bears the CE Mark. All electric heaters are tested and approved. Depending on their capacity, they come with additional certificates from Intertek Semko according to: Low-Voltage Directive: EN 60335-1 and EN 60335-2-30; EMC Directive: EN 61000-6-3 and EN 61000-6-1; EMF Directive: EN 62233.

Electric air heaters come with IP43 protection as standard, and are also available as IP55 or IP65 devices. If required, they can be equipped with an integrated controller. A floating alarm relay signals whether the manually resettable overheating protection has been tripped. The heaters feature electronic air flow sensors and are controlled by means of integrated temperature controllers connected to room and duct temperature sensors. Alternatively the heating register can be controlled by an external system. Modbus communication is available as an option.

HEATER (EH)

Our heaters are fin heat exchangers.

The heater consists of:

- High-performance fins in aluminium
- Mechanically expanded, seamless copper pipe permanently attached to the fins

- Heat exchanger frame, made from galvanised sheet steel as standard; frames in stainless steel, aluminium and other materials are available on request
- Copper collector
- Brass water fitting with inch thread
- Discharge and venting valve as standard
- Pipe penetrations sealed with permanent elastic sealant, covered by rubber rosettes, chosen to suit the heating medium

The special fixture securing the exchanger pack in the frame prevents thermally induced stress between the frame and the copper pipes. If required, the heat exchanger can be easily pulled from the housing.

Both the heat exchanger and the fins can be customised as regards materials, dimensions and other properties. The tubes and pipes are available in copper, standard, galvanised or stainless steel with various wall thicknesses. The inner surface of the copper tubes can be smooth or structured for optimised medium flow.

We offer fins in aluminium, tin-plated copper or coated aluminium with hydrophobic or hydrophilic properties. They are tested at 30 bar, and the maximum permissible operating pressure is 16 bar. If the heat exchanger is to be used as a condenser for operation with a refrigerant, the heater is completely cleaned, dried and filled with nitrogen. All connections are airtight.

FROST PROTECTION FRAME (FS)

The frost protection frame is made from galvanised sheet steel or stainless steel and features a capillary frost protection thermostat. Integrated frost protection frames are designed as drawers. They can be accessed by opening a maintenance panel equipped with locking clamps that allow for airtight closing of the panel.

CHILLER (KH)

The chiller is a fin heat exchanger designed for operation with cold water or a water-glycol mixture.

The chiller consists of:

- High-performance fins in aluminium
- Mechanically expanded, seamless copper pipe permanently attached to the fins
- Heat exchanger frame, made from stainless steel as standard; frames in aluminium and other materials are available on request
- Copper collector
- Brass water fitting with inch thread
- Discharge and venting valve as standard
- Pipe penetrations sealed with permanent elastic sealant, covered by rubber rosettes, chosen to suit the heating medium

A special fixture securing the exchanger pack in the frame prevents thermally induced stress between the frame and the copper pipes. If required, the heat exchanger can be easily pulled from the housing. Both the heat exchanger and the fins can be customised as regards materials, dimensions and other properties.

The tubes and pipes are available in copper, standard, galvanised or stainless steel with various wall thicknesses. The inner surface of the copper tubes can be smooth or structured for optimised medium flow. We offer fins in aluminium, tin-plated copper or coated aluminium with hydrophobic or hydrophilic properties. They are tested at 30 bar, and the maximum permissible operating pressure is 16 bar.

If the heat exchanger is to be used as an evaporator for operation with a refrigerant, the chiller is completely cleaned, dried and filled with nitrogen. All connections are airtight. The medium inlet features a distribution spider and Venturi nozzles.

The device base under the heat exchanger is designed as a three-dimensionally inclined condensate collecting tray made in stainless steel according to VDI 6022 and VDI 3803, ensuring fast discharge through the drain fitting. As an option, we offer V-shaped trays for installation into the base of the device. The condensate outlets have a diameter of minimum 1" and are equipped with a male thread for the attachment of a siphon. At air velocities of greater than 2.7 m/s across the chilling surface of the heat exchanger, we recommend installing a demister to ensure proper collection of the condensate.

DEMISTER (TA)

The demister pack consists of profiled polypropylene fins with high separation properties and low air resistance. The fins are enclosed in a self-contained housing and can be individually removed for cleaning. The housing frame is available in aluminium or stainless steel. In the air handling unit, the demisters are installed on rails mounted to the condensate collecting tray so that they can be pulled out individually, for maintenance, etc. The demister can be accessed by opening a maintenance panel equipped with locking clamps that allow for airtight closing of the panel.

Heat recovery systems

Heat recovery is a term used to describe a wide range of methods and technologies that allow for the recovery of thermal energy from one process for use in another process. In air handling systems, the term normally refers to the transfer of heat from the exhaust air to the fresh air. Heat recovery helps minimise the primary energy consumption of a building. There are many different heat recovery systems available in the market, and their installation in air handling and air conditioning units has already become a legal requirement in many countries. The relevant definitions and specifications are laid down in the applicable standards and guidelines. There are basically two methods of heat recovery, namely recuperative and regenerative heat recovery.

Since the introduction of the European Ecodesign Directive, which lays down the maximum permissible power consumption as well as the minimum energy-efficiency of "relevant energy-using products", heat recovery technology has taken a leap forward. Within a very short period of time, huge progress has been made with regard to efficiency and reliability.

PLATE HEAT EXCHANGER (PT)

Plate heat exchangers are energy recovery systems consisting of an exchanger stack placed in a housing. They are designed for heat recovery during the cold season, and cold recovery during the hot months of the year. The exchanger stack consists of aluminium or stainless-steel plates separated by V-shaped spacers whose profile is optimised for unobstructed air flow. This ensures perfect spacing of the plates, which are cross-stacked for extra rigidity. The design guarantees optimum heat recovery rates, whereby the thermal efficiency is largely unaffected by the air velocity. The air intake section is reinforced by the interlocking flanges. This design guarantees the complete separation of the two air flows. The plates are permanently yet flexibly joined to each other and sealed with a heat-resistant compound. The air flows cross each other at right angles, so that there is virtually no transfer of moisture or odours. Leakage can be minimised or even fully prevented by optimising the position of the fans. The corners of the heat exchanger stack are encased in extra sturdy, hollow extruded aluminium profiles, set in epoxy resin and screwed to the side panels. These are made from aluminium-zinc coated sheet steel as standard. Painted panels are available on request. Depending on the actual installation position, the condensate outlet can face in any direction. The design of the plate heat exchanger fits all unit configurations and combinations. The suitability of the heat exchangers

for use in general air handling units and in systems for hospitals has been verified by independent testing bodies (TUEV Süd) and is certified by industry associations (Herstellerverband RLT-Geräte e.V., Eurovent). An integrated fresh air bypass protects the exchanger against frost and allows for passive cooling and/or heat exchanger control. If required, the bypass can be integrated in the exhaust air system, for instance to reduce the output and to minimise pressure loss during partial-load operation. Such an integration is also recommended where the exhaust air is highly contaminated. A hybrid option of the above two bypass versions is the recirculation air bypass function, which is suitable for mixed-air operation (depending on the technical data). The bypass damper is included in the scope of delivery.

We offer a range of accessories such as positioning axes that protrude from the housing, or internal adapters for the installation of servo motors. Another option from Weger are double-plate heat exchangers: In order to boost the heat transfer performance and the heat recovery rate, several plate heat exchangers are combined into a single exchanger unit. Depending on the space available and the actual unit configuration, the individual exchangers can be positioned parallel or diagonally to each other.

The standard plate heat exchanger models are temperature-resistant. Silicone-free models can withstand temperatures up to 90 °C, while special models with silicone seals are approved for temperatures up to 200 °C.

The base below the plate heat exchanger is made in stainless steel and designed as a condensate collecting tray. It conforms to VDI 6022 and VDI 3803 and is three-dimensionally inclined to ensure fast condensate discharge through the drain fitting. The condensate outlets have a diameter of minimum 1" and are equipped with a male thread for the attachment of a siphon. To increase the dehumidification rate of a plate heat exchanger, in combination with higher air velocities through the cross-section, we recommend installing a demister.

COUNTERFLOW HEAT EXCHANGER (GSWT)

Counterflow heat exchangers are based on the principle of crossflow heat exchangers. The exhaust and fresh air flows are again completely separated, and fed along thin, parallel fins. As the horizontal flow path inside the heat exchanger is extended, there is not only a crossflow but also a counterflow of air, which results in an even higher heat recovery rate, and the complete elimination of any risk of moisture or odour transfer.

Counterflow heat exchangers are available in the following versions:

- Aluminium
- Aluminium with anti-corrosive epoxy coating
- Plastic

The special pattern on the plates ensures high efficiency combined with low pressure loss and excellent stability. For applications that require extra high differential pressure strength, we offer a special model that can withstand differential pressures of up to 1800 Pascal. The housing of our counterflow heat exchangers is made in pure aluminium as standard (sea water resistant). An integrated fresh air bypass protects the exchanger against frost and allows for passive cooling and/or heat exchanger control. Alternatively, the bypass can be placed in the exhaust air flow, for instance to reduce power consumption and pressure loss under partial load or where the exhaust air is heavily contaminated. The bypass damper is included in the scope of delivery.

We offer a range of accessories such as positioning axes that protrude from the housing, or internal adapters for the installation of servo motors. The base below the counterflow heat exchanger is made in stainless steel and designed as a condensate collecting tray. It conforms to VDI 6022 and VDI 3803 and is three-dimensionally inclined to ensure fast condensate discharge through the drain fitting. The condensate outlets have a diameter of minimum 1" and are equipped with a male thread for the attachment of a siphon. To increase the dehumidification rate of a crossflow heat exchanger, in combination with higher air velocities through the cross-section, we recommend installing a demister.

RUN AROUND COIL SYSTEM (KV)

Run around coil systems are regenerative energy recovery systems incorporating one or more heat exchangers in the fresh air and exhaust air flows. These types of energy recovery systems have the advantage that the air flows are physically separated from each other. They are therefore particularly suitable for applications where, for hygiene reasons, it is crucial that there is no cross-contamination between the air streams. It is even possible to install the fresh air and the exhaust air equipment in two separate rooms, further minimising the risk of transfer of odours, germs and other contaminants. The heat exchangers are linked to the on-site pipeline system through a hydraulic circuit. Suitable heat transfer mediums are water or water-glycol mixtures. As accessories, we offer a hydraulic module (HPS), including the intelligent IMPERIA 51 HPS control unit, which turns the installation into a high-efficiency system. Apart from heat recovery, run around coil

systems can be upgraded with a range of optional devices that boost the overall efficiency of the unit, for instance by integrating secondary energy.

ROTARY HEAT EXCHANGER (RT)

Rotary heat exchangers are regenerative energy recovery systems designed in the shape of a wheel with a rotating honeycomb matrix. The wheel is driven by a separate motor, a worm drive and a drive belt. This self-tensioning belt is fitted around the circumference of the wheel and keeps the matrix in motion. The geared motor comes with integrated acceleration and deceleration ramps for a long service life.

The matrix consists of a non-corrosive, wound aluminium strip that is folded for proper spacing, divided into segments, arranged to provide circular contact faces and attached to the rotor that is equipped with lubricated-for-life anti-friction bearings.

The matrix is encased in a sturdy housing that forms a cassette for easy installation in the air handling unit. All components of the rotary heat exchanger are freely accessible for maintenance. The wheel housing is available in galvanised steel, aluminium and stainless steel. Its design ensures that there are no un-ventilated zones. To prevent leakage, the rotary heat exchanger features a circumferential, wear-resistance sliding seal made from hygienically safe materials. It can be equipped with a flushing chamber to further reduce or even fully eliminate contact between the air flows. In this chamber, a part of the fresh air stream is diverted to the exhaust air side for flushing and to prevent that exhaust air side components rotate together with the fresh air side components. A flushing chamber is however only effective, if the pressure differentials and the ventilation are correctly configured.

The basic rotary heat exchanger model designed for heat recovery only is equipped with a condensation rotor. For the transfer of heat and moisture, it is also possible to use an enthalpy or a sorption wheel. Such rotary heat exchangers come with a hygroscopic coating to facilitate the transfer of moisture, and allow for high thermal and moisture transfer rates throughout the year. Rotary heat exchangers can also be fitted with a special epoxy-coated aluminium foil for extra protection against corrosion. Such exchangers are ideal for use in environments with aggressive or corrosive air (for example in indoor pools, paint shops, industrial extraction plants, farm stables, etc.).

All models and sizes can be installed vertically or horizontally. The matrix can be cleaned with air, steam, water or – if necessary – with special chemicals.

All our rotary heat exchangers are equipped with a simple control system and a user-friendly LCD panel with menus where operators can set the parameter values, call up functions and read error messages. The control system caters for external ON/OFF signals, variable speed regulation through 0-10 V or 4-20 mA, as well as integrated rotor control as standard. A thermal protection contact or PTC resistor protects the drive against overheating.

Humidification systems

The recommended minimum air humidity varies from application to application and must thus be determined on a case-to-case basis. For health reasons, the relative air humidity in closed rooms should be between 40 and 60%. In modern buildings with well insulated shells and efficient heating and ventilation systems, these recommended values are often not achievable without a humidification system. A comfortable air humidity boosts performance at the workplace, and also helps protect historic artefacts. In fact, the moisture content of air is such an important factor for our well-being that many countries have already introduced legislation governing the operation and maintenance of humidification systems. On sites where steam is produced, it makes of course sense to run steam humidifiers.

STEAM HUMIDIFIER (DB)

The humidification of air with steam at a generally constant air temperature is also known as isothermal air humidification. Electrically powered steam generators operate either according to an electrode principle or resistance principle. In the case of electrode humidifiers, grid-shaped metallic electrodes are immersed in the water tank of the unit, making use of the conductivity of water. The current in these humidifiers flows directly through the water medium and causes evaporation. With this method, the amount of steam produced is controlled through the level of water in the steam cylinder. The electrode heater allows for reliable steam production using drinking water. The process is automatically adjusted to the available water quality so that the water consumption of the unit is optimised.

The alloys from which the electrodes are made guarantee virtually loss-free transfer of the energy to the water. Electrode heaters for steam humidification are known to be highly reliable, combining effective steam generation with a long service life. In resistance steam humidifiers, water is heated according to the principle of immersion heaters. The operation of the humidification system is not affected by the conduc-

tivity of the water used in the process. This method is suitable for operation with treated water as well as with drinking water. A patented limescale management system that comes as standard prevents limescale deposits on the heating rods, prolonging the unit's service life and cutting down on maintenance.

All steam generators are shipped with a control system that monitors its functions, output, maintenance intervals, etc. Depending on the specifications of the system, air humidification with steam can be controlled with high precision. As the medium used in the process is heated to more than 100 °C, there are also no hygiene issues. Irrespective of the method used for the production of the steam, our humidifiers feature a technically advanced steam distribution system that makes sure that the humid air is distributed evenly across the air handling system.

The walls of the humidifier chamber consist of corrosion-proof aluminium or stainless-steel panels. The base of the device is designed as a three-dimensionally inclined condensate collecting tray made in stainless steel according to VDI 6022 and VDI 3803, ensuring fast discharge through the drain fitting. The condensate outlets have a diameter of minimum 1" and are equipped with a male thread for the attachment of a siphon. Accessories available for this type of humidifier include damp room LED lamps and black-out sight glasses.

SURFACE HUMIDIFIER (OFB)

Surface humidifiers can be used for both air humidification and evaporative cooling. A manifold pipe feeds water at a constant rate across panels installed above the evaporator body. By choosing the right material for the evaporator body, it is possible to optimise the performance of the system to suit any application and unit layout. The actual surface humidifier is a double-wall tank with an inlet, outlet and overflow. There are two basic models, namely one for recirculated water and one for fresh water, whereby both models can be upgraded with a range of accessories, such as an integrated, water-resistant and energy-efficient recirculating pump, or a tank with float valve. We also offer an intelligent control system with touch screen and a range of useful functions for remote operation, maintenance and troubleshooting, integrated auto-diagnostics and parameter monitoring for water purification. To meet specific hygiene requirements, the water tank can be equipped with an UV lamp. Other available accessories include damp room LED lamps and black-out sight glasses.

HIGH-PRESSURE HUMIDIFIER (HDB)

High-pressure humidifiers are also known as adiabatic humidifiers. These systems work with special high-pressure nozzles through which water droplets are dispersed into the air. The nozzles are supplied with demineralised water and produce a mist that is quickly absorbed by the ambient air. The air entering the humidifier is fed through a vortex generator that generates stable longitudinal vortices, ensuring an optimal water/air mix during the reaction time. At the centre of each vortex, the water is dispersed under high pressure through nozzles. As the air absorbs the water, it is adiabatically cooled. As the spray mist distribution is extremely homogeneous, the droplets evaporate very quickly, which makes high-pressure humidifiers particularly efficient. A downstream evaporator installed at the air outlet evaporates any water that is not taken up by the air. If the saturation point of the air is reached, the excess water is drained off. Accessories available for this type of humidifier include damp room LED lamps and black-out sight glasses.

AIR WASHER (LW)

Air washers serve as adiabatic humidifiers while also cleaning the air. They are therefore generally classified as recirculating spray humidifiers. Air washers are able to compensate for fluctuations in the humidification performance and pollution load, ensuring a constant high water quality. As water evaporates while dirt particles are held back, the recirculated water becomes more polluted, and needs to be purified from time to time to prevent excessive contamination of the system. To meet more stringent hygiene standards, the unit can be equipped with UV-C technology. Other available accessories include damp room LED lamps and black-out sight glasses.

Fans

A fan is an externally driven apparatus that creates a flow of air for cooling or ventilation. Fans are therefore at the heart of all air handling units. They feature impellers mounted on a shaft and driven by a motor. The impeller blades come in various shapes and designs, depending on the type of fan. As the impeller rotates, air is taken in at one side, and blown out at the other side, producing an air stream in the air handling system. The main considerations when choosing a fan are capacity, efficiency and sound emission.

FAN WITH BELT DRIVE (VR)

Belt-driven fans are high-performance, dual-suction radial fans fitted with forward or backward curved blades. Depending on the model, the impeller is made

from galvanised sheet steel, coated steel or polyamide. In backward curved fans, the impeller blades are made from hollow profiles. The spiral housing is lock-formed or welded. Our housings are galvanised as standard. For operation in corrosive environments, we offer a coated version. Fans intended for operation under high pressure can be fitted with a reinforcing frame. If required, the outlet side can be equipped with a connecting flange. The welded and coated outlet edge is at an angle to the impeller axis. The inlet opening is designed for minimum drag, and the impeller is statically and dynamically balanced according to DIN ISO 1940.

It features low-noise precision ball bearings that are generally maintenance-free and self-aligning with balls in the outer race. The bearings are embedded in rubber damping bushes and secured with galvanised struts to the housing. We also offer models with a cast housing and tubular strut fixtures. If required, the bearings can be lubricated while the fan is running.

The fan and the motor are mounted with vibration-damping rubber or spring elements on a single supporting structure made from special profiles. The motor can be positioned by means of a base plate that can be moved parallel to the axis, and a central adjusting screw. The air outlet of the fan is attached to the device housing with elastic connectors. The fan is driven by a three-phase motor that conforms to the relevant IE standards and VDE 0530. The standard model is designed for 380–420 V and 50 Hz, protection class IP 54, model B3, insulation class F, and equipped with a single-speed, multiple-speed or continuous speed controller.

The belt drive consists of an electrically conductive heavy-duty V-belt and pulleys made in aluminium or cast iron. We also offer drives with flat belts. The pulleys are mounted with Taper-Lock tensioning elements and tongued and grooved connectors.

Belt-driven fans have the advantage that they can be easily adjusted to changing operating conditions, for instance by installing a different belt drive (pulleys).

These fans normally operate as dual-suction fans, offering high performance and equally high efficiency while the noise emissions are relatively low, thanks to the special blade profile and arrangement and the angled air outlet edge. As we offer a wide range of accessories for fans, they can be configured and equipped for maximum flexibility, extra protection against corrosion and minimum maintenance. Among the most popular optional components are condensate drains, inspection hatches, stainless steel shafts, guard grilles, etc. Other accessories are available on request.

IMPACT DIFFUSER (P)

The impact diffuser is installed downstream of the fan (pressure side). It consists of a perforated plate made in galvanised sheet steel or stainless steel and is designed to distribute the air as required and to ensure optimised air flow to the downstream system components.

FAN WITH FREE-RUNNING IMPELLER (VF)

Fans with free-running impellers are radial fans where the impeller is driven directly by the motor. They are compact modules with a high system efficiency designed and optimised for operation with a horizontal axis and without a spiral housing.

A recently developed high-performance impeller with an optimised geometry for maximum efficiency features backward curved blades with aerodynamic profiles. Thanks to the innovative design of the blade surfaces, the sound pressure level is very low and noise emission is diffuse. The impeller is manufactured in an automated process from high-strength sheet steel. It is robot-welded, degreased, phosphatised and protected by a high-grade epoxy-polyester coating. We also offer impellers made in polyamide. The impeller is secured with a clamping bush to the shaft of the surface-mounted motor. It is statically and dynamically balanced according to DIN ISO 1940 to balance quality grade G 2.5 at maximum speed. The system intake nozzle made from galvanised sheet steel and designed for optimised air flow to the impeller is equipped with a volumetric flow measuring device monitoring the fan operation as standard. The measuring connection is integrated into the intake nozzle. The impeller performance meets the requirements of DIN 24166 accuracy class 1. The module is factory-configured for optimum performance and mounted on a base frame equipped with vibration dampers.

The fan is driven by an internal rotor motor. With EC technology, it consists of a permanent magnet motor with attached controller. The AC technology solution is an asynchronous motor with controller.

Silencers

To meet modern sound protection standards, most AHU systems need to be fitted with silencers. In air handling systems, noise tends to be produced at various points within the unit. The main sources are fans. Components with unfavourable flow properties are however also a problem, and often amplify the noise made by other system parts.

SILENCER (SD)

The splitter silencer reduces noise inside the air flow through resonance and adsorption.

The silencer consists of:

- Aerodynamically designed profiled frame whose radius is chosen to reduce pressure loss
- Square-edged frame holding the mineral wool
- Frames made in galvanised or coated sheet steel, or in stainless steel
- The absorption material is mineral wool that poses no risk to health and is not flammable according to DIN 4102, building material class A. It is covered by a glass silk fabric that protects it against abrasion up to an air velocity of 20 m/s.

The splitter silencers are mounted upright by means of special cam guide rails with which they can be aligned within the housing. For cleaning, the silencer can be easily removed from the unit from the operator side. The splitter panels are available in sizes from 200 to 400 mm, and can be combined for larger dimensions, if necessary. The silencers are designed for operation with normal, non-aggressive air at a temperature of maximum 100 °C. Optional accessories include perforated cover panels, or split resonance panels. They come with full documentation regarding compliance with the hygiene requirements according to VDI 6022, DIN 1946 and VDI 3803.

Empty sections

As the needs and expectations of users change, so do the requirements to be met by air handling units. Apart from efficiency, operators focus more and more on the service life of their systems. To ensure reliable operation over a long period of time, units need to be regularly inspected, serviced and cleaned. To do this, the various unit components must be accessible, and there must be sufficient space available to perform the various tasks in a cost-effective manner. That is why we strongly recommend integrating a sufficient number of “empty sections” in all units, in particular upstream and downstream of built-in components.

EMPTY SECTION (L)

Empty sections are available in any length. They can be equipped with access doors for maintenance, or serve as airflow-calming sections. We recommend installing empty sections upstream and downstream of all components that need regular inspection, cleaning and/or servicing. There are several locking systems for access doors and panels, catering for all needs. Some are particularly useful where space in the tech-

nology room is restricted. The locking systems are described in detail on [page 38](#).

Choice of locking systems:

- Detachable maintenance panel with locking clamps (RAK)
- Detachable maintenance panel with square key locks (lock bolts) (RAS)
- Maintenance door with square key locks (RTS)
- Maintenance door with locking handle (RTH)
- Detachable maintenance panel with surface-mounted lock (RAV)
- Maintenance door with surface-mounted lock (RTV)

Housing connections

Size	Unit connection W x H (mm)	STS Canvas connector		JKL Air-control damper, external		WSG Weather guards		EKS Decoupled adapter		URA U-frame		GGR Counter-frame		JKL Air-control damper, internal		ASH Air intake/outlet hood							
		kg	H _r	kg	H _r	kg	H _r	kg	H _r	kg	H _r	kg	H _r	kg	H _r	L	W	H	kg				
64	610 x 474	3	230	2	16	230	13	6	230	3	2	230	2	2	230	2	16	230	13	550	1	1	6
66	610 x 667	3	342	2	20	342	16	8	342	4	3	342	2	3	342	2	20	342	16	550	1	1	7
96	915 x 667	4	342	3	26	342	20	12	342	6	3	342	3	3	342	3	26	342	20	550	1	1	8
126	1220 x 667	5	342	4	33	342	25	16	342	8	4	342	3	4	342	3	33	342	25	550	1	1	10
99	915 x 972	5	455	4	35	455	25	18	455	8	4	455	3	4	455	3	35	455	25	550	1	1	12
129	1220 x 972	6	455	4	43	455	31	24	455	11	4	455	3	4	455	3	43	455	31	550	1	1	14
1212	1220 x 1277	6	678	5	54	678	39	31	678	17	5	678	4	5	678	4	54	678	39	550	1	2	19
1512	1525 x 1277	7	678	6	64	678	46	39	678	21	6	678	4	6	678	4	64	678	46	550	1	2	22
1812	1830 x 1277	8	678	7	74	678	53	47	678	25	6	678	5	6	678	5	74	678	53	550	1	2	25
1515	1525 x 1582	8	792	6	76	792	52	48	792	24	6	792	5	6	792	5	76	792	52	660	1	2	27
1815	1830 x 1582	9	792	7	89	792	60	58	792	29	7	792	5	7	792	5	89	792	60	660	1	2	30
1818	1830 x 1887	10	1017	7	103	1017	71	69	1017	37	7	1017	6	7	1017	6	103	1017	71	660	1	2	34
2118	2135 x 1887	10	1017	8	117	1017	80	81	1017	43	8	1017	6	8	1017	6	117	1017	80	660	1	2	38
2518	2440 x 1887	11	1017	9	131	1017	89	85	1017	46	8	1017	8	8	1017	8	131	1017	89	660	1	3	41
2121	2135 x 2192	11	1130	8	133	1130	87	94	1130	48	8	1130	6	8	1130	7	133	1130	87	720	1	3	51
2521	2440 x 2192	12	1130	9	149	1130	97	107	1130	55	10	1130	8	10	1130	8	149	1130	97	720	1	3	56
2525	2440 x 2497	13	1242	10	166	1242	105	122	1242	61	11	1242	9	11	1242	7	166	1242	105	720	1	3	60
2825	2825 x 2497	14	1242	11	189	1242	118	137	1242	68	12	1242	10	12	1242	8	189	1242	118	720	1	3	82
3125	3130 x 2497	15	1242	11	207	1242	128	152	1242	76	13	1242	11	13	1242	9	207	1242	128	720	2	3	87

EN 13180 air tightness class C. Optional: insulated version. VZ/V2A frame. Flange width 30 mm/DIN 24193 frame drill pattern R1. Temperature-resistant to 80°C/160°C.

TUEV-certified for airtightness according to EN 1751 and DIN 1946. Flange width 30 mm (connecting bores Ø 9.5 mm). From height 1130 mm with 2 positioning axes; from 1580 mm with 3 positioning axes and connecting rods. 12 x 12 mm square positioning axis. Weatherproof models: Damper with adjusting lever inside device.

Weather guard in aluminium or V2A (optional). Distance between fins 62.5 mm. Rear-mounted bird guard, galvanised (optional: V2A); mesh size 15 mm. Max. air velocity according to DIN EN 13053: external air 2.5 m/s; outlet air 4.0 m/s.

Frame galvanised (standard), V2A or powder-coated (optional). Flange width 30 mm (connecting bores Ø 11 mm).

Frame galvanised (standard), V2A or powder-coated (optional). Flange width 30 mm (connecting bores Ø 8 mm).

Frame galvanised (standard) or V2A (optional).

In aluminium (standard), galvanised or V2A (optional). Rear-mounted bird guard, galvanised (optional: V2A); mesh size 15 mm. Max. air velocity according to DIN EN 13053: external air 4.5 m/s; outlet air 6.0 m/s.

Air intake and outlet systems

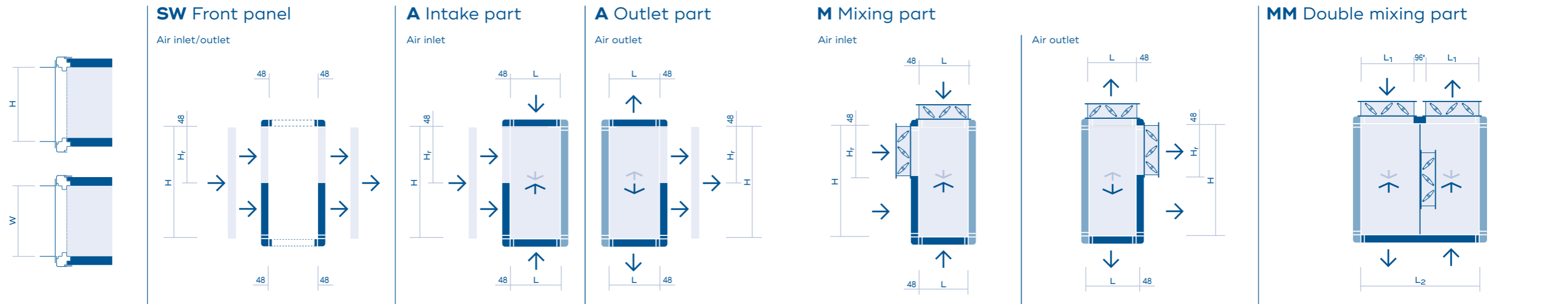

Size	Unit connection W x H (mm)	SW Front panel			A Intake part			A Outlet part			M Mixing part			MM Double mixing part			Internal device	External device	kg	
		H _r	L	kg	H _r	L	kg	H _r	L	kg	H _r	L	kg	H _r	L	kg	L ₁	L ₂		
64	610 x 474	230	48	4	230	230	34	230	230	34	230	230	37	230	230	37	230	556	690	49
66	610 x 667	342	48	5	342	342	37	342	342	37	342	342	40	342	342	40	342	780	914	55
96	915 x 667	342	48	6	342	342	42	342	342	42	342	342	46	342	342	46	342	780	914	70
126	1220 x 667	342	48	8	342	342	58	342	342	58	342	342	64	342	342	64	342	780	914	89
99	915 x 972	455	48	8	455	455	66	455	455	66	455	455	73	455	455	73	455	1006	1140	119
129	1220 x 972	455	48	9	455	455	75	455	455	75	455	455	82	455	455	82	455	1006	1140	132
1212	1220 x 1277	678	48	10	678	678	95	678	678	95	678	678	104	678	678	104	678	1452	1586	177
1512	1525 x 1277	678	48	11	678	678	119	678	678	119	678	678	131	678	678	131	678	1452	1586	224
1812	1830 x 1277	678	48	12	678	678	130	678	678	130	678	678	143	678	678	143	678	1452	1586	244
1515	1525 x 1582	792	48	13	792	792	131	792	792	131	792	792	144	792	792	144	792	1680	1814	282
1815	1830 x 1582	792	48	14	792	792	172	792	792	172	792	792	189	792	792	189	792	1680	1814	309
1818	1830 x 1887	1017	48	15	1017	1017	205	1017	1017	205	1017	1017	225	1017	1017	225	1017	2130	2264	373
2118	2135 x 1887	1017	48	16	1017	1017	226	1017	1017	226	1017	1017	248	1017	1017	248	1017	2130	2264	404
2518	2440 x 1887	1017	48	17	1017	1017	240	1017	1017	240	1017	1017	264	1017	1017	264	1017	2130	2264	429
2121	2135 x 2192	1130	48	17	1130	1130	261	1130	1130	261	1130	1130	288	1130	1130	288	1130	2356	2490	489
2521	2440 x 2192	1130	48	19	1130	1130	310	1130	1130	310	1130	1130	341	1130	1130	341	1130	2356	2490	570
2525	2440 x 2497	1242	48	20	1242	1242	366	1242	1242	366	1242	1242	403	1242	1242	403	1242	2580	2714	670
2825	2825 x 2497	1242	48	21	1242	1242	386	1242	1242	386	1242	1242	425	1242	1242	425	1242	2580	2714	705
3125	3130 x 2497	1242	48	22	1242	1242	415	1242	1242	415	1242	1242	456	1242	1242	456	1242	2580	2714	746

Equip fresh air inlet part with tray, if required.

For mixing chamber operation with expected temperature layers, we recommend installing the heater behind the fan. In weatherproof models, the dampers are installed on the inside.

In weatherproof models, the distance between the dampers at the same position is 230 mm (instead of 96 mm). In weatherproof models, the dampers are installed on the inside. Mixing part for fresh, recirculated and exhaust air with 3 dampers, of which 2 can be positioned as required.
* In weatherproof executions, the distance is 230 mm (see page 44).

Filters

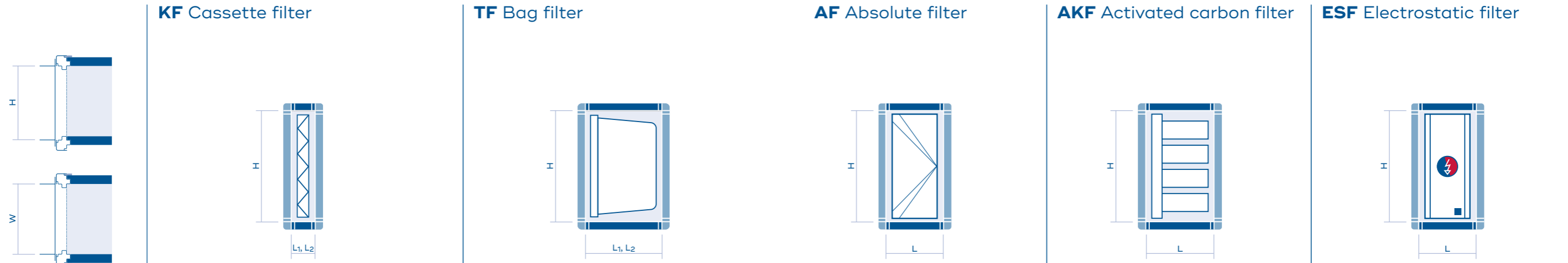

Size	Unit connection W x H (mm)	2 Zoll		4 Zoll		2 Zoll		4 Zoll		L	kg	L	kg	L	kg
		L ₁	kg	L ₂	kg	L ₁ *	kg	L ₂	kg						
64	610 x 474	130	18	180	23	458	45	680	61	458	52	610	113	610	62
66	610 x 667	130	22	180	28	458	54	680	71	458	68	610	162	610	78
96	915 x 667	130	27	180	35	458	66	680	87	458	87	610	219	610	99
126	1220 x 667	130	32	180	42	458	79	680	103	458	107	610	271	610	120
99	915 x 972	130	32	180	42	458	79	680	103	458	107	610	279	610	120
129	1220 x 972	130	38	180	51	458	94	680	120	458	136	610	373	610	149
1212	1220 x 1277	130	44	180	61	458	109	680	137	458	165	610	467	610	178
1512	1525 x 1277	130	51	180	70	458	125	680	154	458	194	610	565	610	207
1812	1830 x 1277	130	57	180	79	458	140	680	172	458	223	610	658	610	236
1515	1525 x 1582	130	57	180	79	458	140	680	172	458	223	610	669	610	236
1815	1830 x 1582	130	63	180	88	458	155	680	189	458	253	610	803	610	265
1818	1830 x 1887	130	71	180	101	458	175	680	209	458	301	610	937	610	310
2118	2135 x 1887	130	78	180	112	458	193	680	228	458	339	610	1079	610	347
2518	2440 x 1887	130	85	180	123	458	210	680	246	458	378	610	1209	610	383
2121	2135 x 2192	130	85	180	123	458	210	680	246	458	378	610	1225	610	383
2521	2440 x 2192	130	85	180	120	458	210	680	255	458	350	610	1396	610	364
2525	2440 x 2497	130	102	180	149	458	250	680	287	458	474	610	1566	610	473
2825	2825 x 2497	130	110	180	162	458	271	680	307	458	522	610	1756	610	518
3125	3130 x 2497	130	118	180	175	458	291	680	327	458	570	610	1928	610	563

On guide rails for removal from the side. Optional metal filter acting as oil or grease trap. With oil or grease trap, we recommend installing a V2A base as a drip tray. Filter class ISO coarse < 30 % (metal filter); ISO coarse > 65 % to ISO ePM1 55 %.

Clamping system (eccentric clamp) with EPDM 45° seal. Filter removable from the side (filter change at dust air side). With filter frame; for filter change at dust air side, install empty section (L min. = bag length + 350 mm) upstream of filter. Filter classes from ISO coarse 50 % to ISO ePM1 90 %. Lint filter, high-temperature filter, oil filter available on request. For light switch L₁, L₂ + 150 mm. For differential pressure measuring devices that are not integrated into the door L₁, L₂ + 200 mm. * L₁ = for compact filter only

Filter frame galvanised (optional: V2A); for filter change at dust air side, install empty section (L min. = bag length + 350 mm) upstream of filter. Filter classes H11 to H14. Filter frame with seal test groove (optional). Pre-filtration minimum ISO ePM1 ≥ 50 % + ISO ePM1 ≥ 80 %.

Cartridge with galvanised housing and bayonet locking mechanism, optional compact filter with integrated prefilter. Standard carbon CEX 003 for odour, ozone and organic vapour absorption. Special impregnated carbon for acidic gases, etc. on request. For installation in intake air section: prefiltration ISO ePM1 ≥ 50 %, secondary filtration ISO ePM1 ≥ 50 %.

Filter removable from the side through access door. Filter can be mounted inside unit with U-profile or filter clamping system (eccentric clamp). Power shutdown by means of safety micro switch at door. With junction box (power supply for system messages).

Heat exchangers

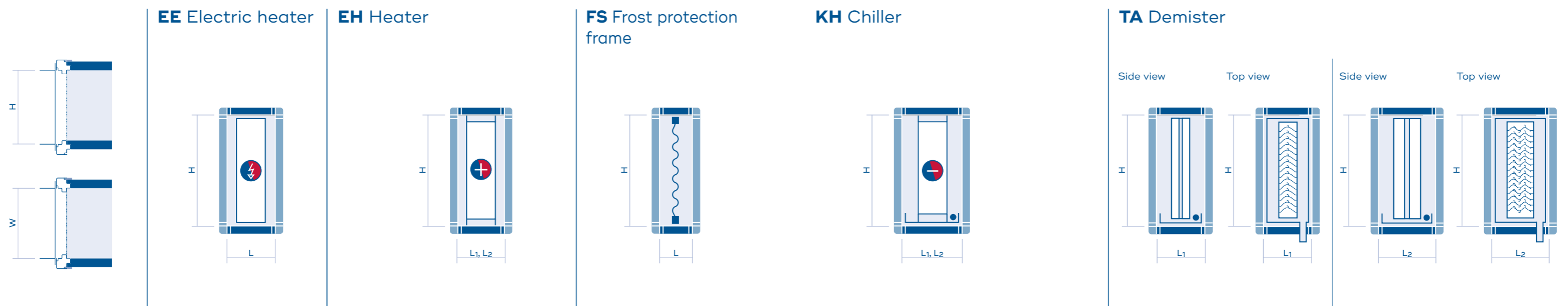

Size	Unit connection W x H (mm)	EE Electric heater		EH Heater		FS Frost protection frame		KH Chiller		TA Demister		L ₁ = 1 tab		L ₂ = 3 tabs			
		L	kg	L ₁	kg	L ₂	kg	L	kg	L ₁	kg	L ₂	kg	L ₂	kg		
64	610 x 474	457	37	200	29	360	46	152	12	420	49	610	65	350	24	400	29
66	610 x 667	457	44	200	38	360	65	152	14	420	69	610	75	350	29	400	35
96	915 x 667	457	53	200	45	360	74	152	18	420	79	610	113	350	38	400	45
126	1220 x 667	457	65	200	55	360	97	152	21	420	103	610	144	350	46	400	56
99	915 x 972	457	65	200	61	360	96	152	21	420	102	610	145	350	46	400	55
129	1220 x 972	457	78	200	70	360	125	152	24	420	132	610	181	350	55	400	67
1212	1220 x 1277	457	87	200	90	360	158	152	27	420	165	610	241	350	64	400	79
1512	1525 x 1277	457	99	200	111	360	202	152	31	420	211	610	292	350	75	400	93
1812	1830 x 1277	457	108	200	126	360	231	152	35	420	240	610	344	350	85	400	106
1515	1525 x 1582	457	111	200	129	360	235	152	34	420	244	610	367	350	85	400	106
1815	1830 x 1582	on request		200	149	360	274	152	38	420	285	610	420	350	96	400	120
1818	1830 x 1887	on request		200	175	360	323	152	41	420	334	610	489	350	107	400	135
2118	2135 x 1887	on request		200	204	360	377	152	44	420	389	610	561	350	120	400	151
2518	2440 x 1887	on request		200	239	360	440	152	48	420	453	610	675	350	132	400	167
2121	2135 x 2192	on request		200	234	360	427	152	48	420	440	610	669	350	131	400	167
2521	2440 x 2192	on request		200	270	360	497	152	51	420	511	610	804	350	145	400	185
2525	2440 x 2497	on request		200	304	360	562	152	54	420	577	610	910	350	158	400	202
2825	2825 x 2497	on request		200	336	360	623	152	59	420	639	610	1010	350	176	400	226
3125	3130 x 2497	on request		200	367	360	682	152	63	420	699	610	1110	350	190	400	245

Register removable from the side; terminal box inside or outside. Switching levels and power according to customer specifications.

With EN 10226-2 pipe thread as standard; also available with fittings for Victaulic or Straub connectors. Recommended face velocity to exchanger surface < 2 m/s. Heat exchangers need to be cleaned at both sides; install empty sections as required. Heat exchanger removable from the side. Discharge/venting fittings as standard. Weight refers to geometry 40 x 35-16 to 3 and 6 tube rows; tube wall thickness 0.4 mm; fin thickness 0.2 mm; fin distance 2.5 mm.

Up to size 1815: removable from the side; larger sizes require accessible empty section for installation of FS at register. In weatherproof models, the frost protection thermostat is mounted on the inside. Frost protection frame galvanised (standard); V2A (optional) on request.

With EN 10226-2 pipe thread as standard; also available with fittings for Victaulic or Straub connectors. Recommended face velocity to exchanger surface < 2 m/s. Heat exchangers need to be cleaned at both sides; install empty sections as required. Heat exchanger removable from the side. Discharge/venting fittings as standard. Weight refers to geometry 40 x 35-16 to 6 and 10 tube rows; wall thickness 0.4 mm; fin thickness 0.2 mm; fin distance 2.5 mm. Tray with 1" outlet, V2A, inclined according to VDI 6022. For arrangement, observe relevant standards (VDI 3803-1). Do not install chiller with dehumidifier in front of silencer or filter.

Recommended where there is condensation (SHR > 0.65) from air velocity of 2.2 m/s over ripped exchanger surface. Frame fins in aluminium-PPT (standard), V2A-PPT or aluminium-aluminium (optional). Demister removable from the side. V2A tray inclined according to VDI 6022. 1" connection as standard; larger connections on request.

Heat recovery systems

PT Plate heat exchanger

Side view - air streams one above the other

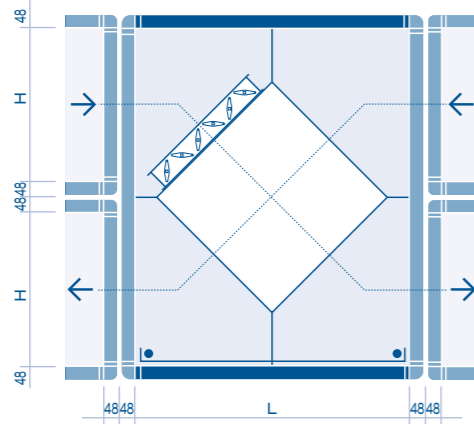
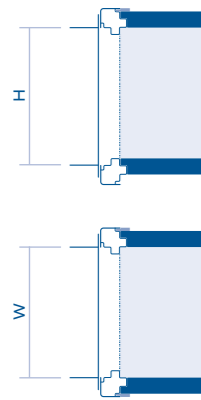

Top view - air streams side by side

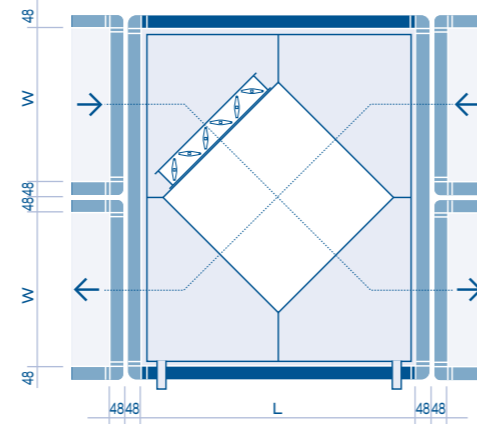

GSWT Counterflow heat exchanger

Side view - air streams one above the other

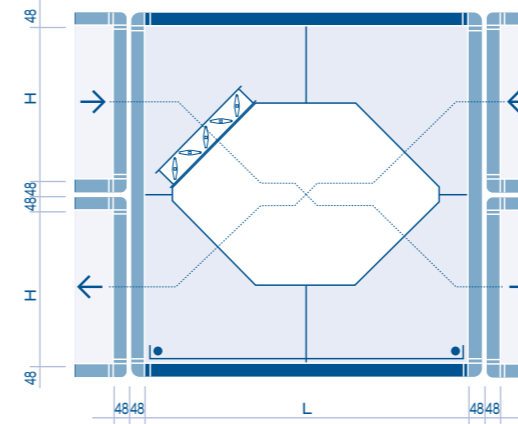

Top view - air streams side by side

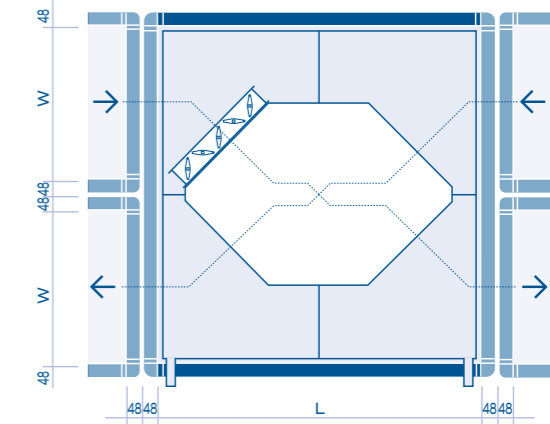

Size	Unit connection W x H (mm)	PT Plate heat exchanger			GSWT Counterflow heat exchanger			GSWT Counterflow heat exchanger			GSWT Counterflow heat exchanger		
		Air volume m ³ /h	L	kg	Air volume m ³ /h	L	kg	Air volume m ³ /h	L	kg	Air volume m ³ /h	L	kg
64	610 x 474	1500	928	190	1300	1102	244	1500	1058	182	1300	1209	209
66	610 x 667	2200	1314	322	1800	1494	274	2200	1209	225	2200	1209	233
96	915 x 667	3400	1314	400	3400	1809	548	3400	1351	306	3400	2056	489
126	1220 x 667	4500	1314	476	3500	1809	622	4500	1209	309	3500	2056	573
99	915 x 972	5000	1526	450	5000	1809	620	5000	1769	459	5000	1809	620
129	1220 x 972	6500	1526	516	5200	1809	693	6500	2056	632	5200	1769	550
1212	1220 x 1277	8600	2505	1280	7500	1809	853	8600	2056	697	7500	2056	713
1512	1525 x 1277	10500	2505	1477	8000	2246	1165	10500	2056	775	8500	2056	796
1812	1830 x 1277	13000	2505	1270	8700	2246	1254	13000	2056	853	8700	2056	882
1515	1525 x 1582	13000	2505	1416	9500	1809	1050	13000	2334	995	9500	2056	882
1815	1830 x 1582	16000	2050	1613	9700	1809	1124	16000	2334	1090	9700	2056	966
1818	1830 x 1887	19000	3492	2385	10800	2246	1693	19000	2602	1354			on request
2118	2135 x 1887	22000	3492	2625	13000	2926	2913	22000	2602	1455			on request
2518	2440 x 1887	25000	3492	2849	15500	2926	2386	25000	2602	1700			on request
2121	2135 x 2192	25000	3492	2710				25000	3692	2400			not available
2521	2440 x 2192	29000	3492	2927				29000	3692	2928			not available
2525	2440 x 2497	33000	3492	3027				33000	3692	3045			not available
2825	2825 x 2497	38000	3492	3303				38000	3692	3218			not available
3125	3130 x 2497	42000	3492	3824				42000	3692	3364			not available

Special model with integrated recirculation air damper (optional, L + 200 mm). Horizontal installation (air streams side by side) to max. size 2518. Dimensions based on air velocity V1. Efficiency according to ERP 2018 minimum 73%. Calculation of recovery rate under dry conditions according to EN 308 +5 °C 0 % / +25 °C 0 %. V2A tray inclined according to VDI 6022 across entire PT section, with 2 connections, 1" as standard; larger connections on request. Enthalpy heat exchangers are available on request. Max. pressure difference on request.

SLK special version (upright/horizontal combination)

PT Plate heat exchanger
Side view - air streams side by side

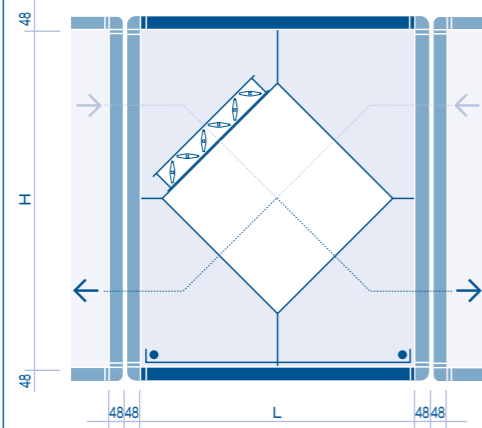
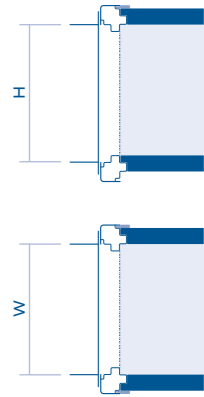

GSWT Counterflow heat exchanger
Side view - air streams side by side

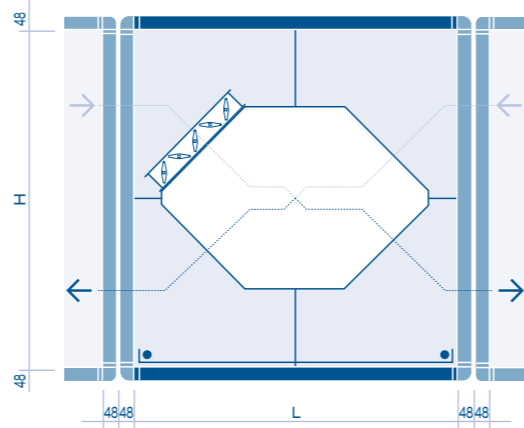

PT plate heat exchanger & **GSWT** counterflow heat exchanger
Top view - air streams side by side

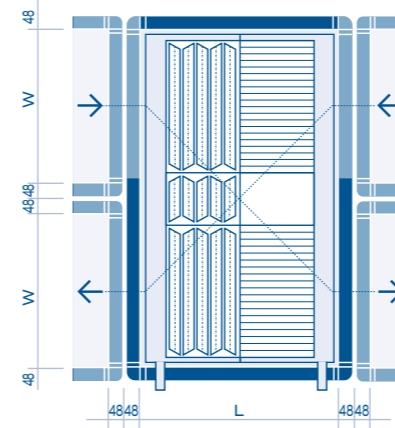

KV Run around coil system

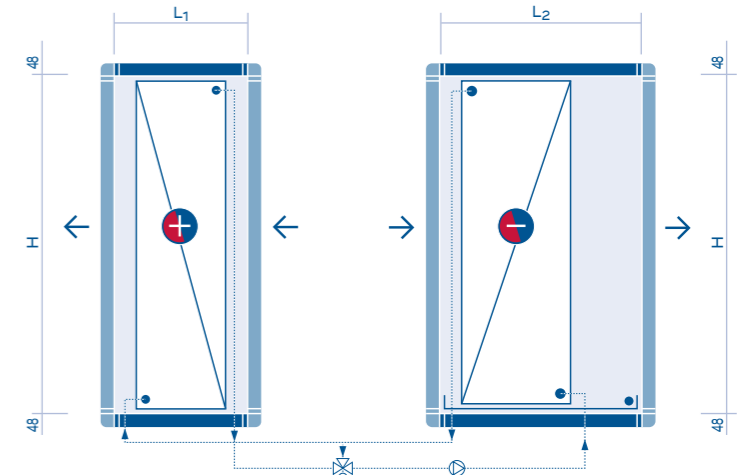

Size	Unit connection W x H (mm)	Crossflow plate heat exchanger			Counterflow heat exchanger		
		Air volume m ³ /h	L	kg	Air volume m ³ /h	L	kg
64	610 x 474	not available			1300	623	128
66	610 x 667	not available			2200	788	171
96	915 x 667	not available			3400	788	226
126	1220 x 667	not available			4200	896	310
99	915 x 972	4000	833	300	5000	1058	332
129	1220 x 972	5200	859	379	6500	927	367
1212	1220 x 1277	8500	1102	634	8700	1209	508
1512	1525 x 1277	10000	1163	805	11000	1209	591
1812	1830 x 1277	12000	1274	960	13500	1307	707
1515	1525 x 1582	13500	1406	961	13500	1351	718
1815	1830 x 1582	16500	1413	972	16500	1351	819
1818	1830 x 1887	19500	1526	1140	19500	1483	925
2118	2135 x 1887	22500	1588	1341	22500	1483	1037
2518	2440 x 1887	26000	1719	1529	26000	1577	1206
2121	2135 x 2192	26500	1809	1905	26500	1769	1268
2521	2440 x 2192	30500	1864	1879	30500	2056	1694
2525	2440 x 2497	34000	1809	2138	34000	2056	1726
2825	2825 x 2497	39000	1869	2429	39000	2056	1938
3125	3130 x 2497	43000	1982	2697	43000	2112	2125

Heater			Chiller		
Air volume m ³ /h	L1	kg	Air volume m ³ /h	L2	kg
on request			on request		
on request			on request		
on request			on request		
on request			on request		
on request			on request		
6000	534	334	6000	654	350
8000	534	413	8000	654	429
10500	534	489	10500	654	519
13000	534	572	13000	654	610
13000	534	587	13000	654	626
16500	534	688	16500	654	735
19800	534	806	19800	654	638
23000	534	927	23000	654	1007
26000	534	1057	26000	654	1152
26000	534	1063	26000	654	1154
30500	534	1212	30500	654	1319
35000	534	1373	35000	654	1495
40000	534	1567	40000	654	1712
44500	534	1724	44500	654	1886

With EN 10226-2 pipe thread as standard; also available with fittings for Victaulic or Straub connectors. Recommended face velocity to exchanger surface < 2 m/s. Heat exchangers must be accessible from both sides for cleaning. Where the air flow is in two directions, install empty sections upstream and downstream of the heat exchanger. Heat exchanger removable from the side. Discharge and venting equipment on the inside (optional on the outside); include detachable maintenance panel for access to discharge and venting equipment. Weight refers to geometry 30x30-16 (flush) to 14 tube rows; tube wall thickness 0.4 mm; fin thickness 0.2 mm; fin distance 2.5 mm (KH) and 2.0 mm (EH). Efficiency according to ERP 2018 minimum 68%. Calculation of recovery rate under dry conditions according to EN 308 +5°C 0% / +25°C 0%.

RT Rotary heat exchanger

Side view - air streams one above the other

Top view - air streams side by side

Top view - air streams one above the other / Rotor centred

Side view - air streams side by side / Rotor 1 side flush

Top view - air streams one above the other / Rotor 1 side flush

Top view - air streams one above the other
Extra wide housing / side view - air streams side by side, with vertical housing extension

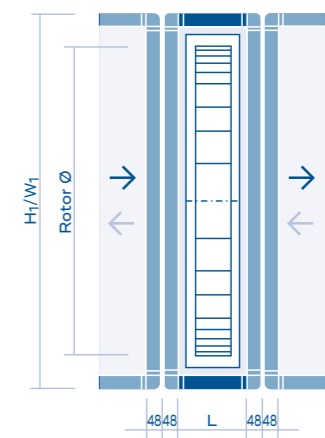
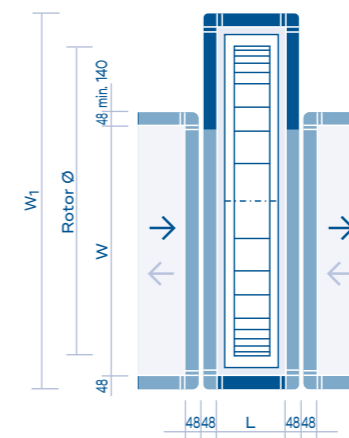
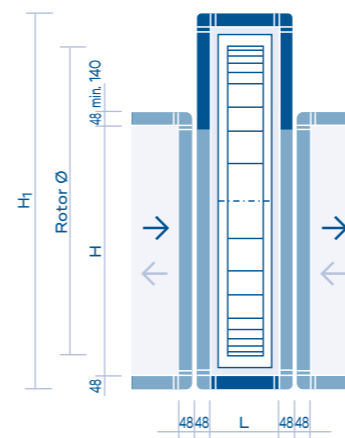
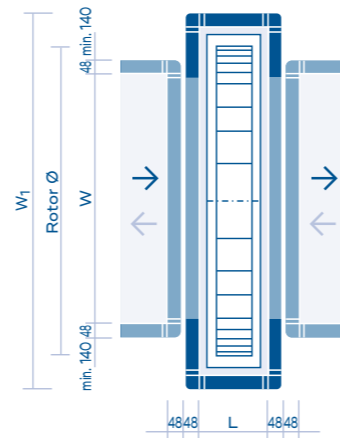
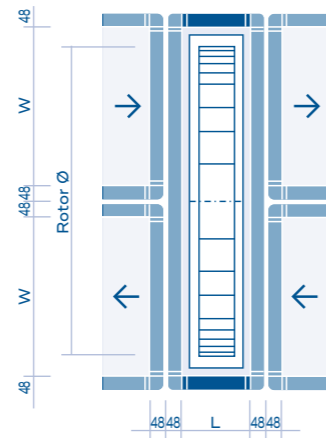
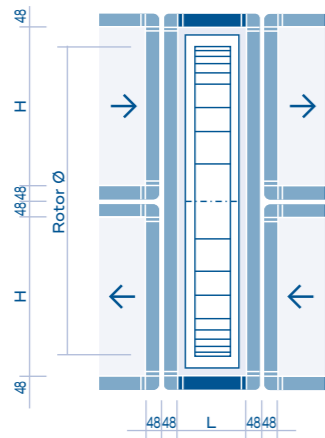
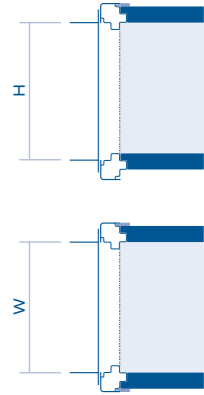

Size	Unit connection W x H (mm)	Air streams one above the other						Air streams side by side					
		W ₁	Rotor (Ø) mm	L	Air volume m ³ /h	kg	H ₁	Rotor (Ø) mm	L	Air volume m ³ /h	kg		
64	610 x 474	851	550	534	1500	132	735	550	534	1500	137		
66	610 x 667	1051	750	534	2200	170	935	750	695	2200	183		
96	915 x 667	1151	950	534	3400	189	1135	950	534	3400	214		
126	1220 x 667	1456	1200	534	4500	244	1385	1200	534	4500	280		
99	915 x 972	1601	1450	534	5000	341	1385	1200	534	5000	256		
129	1220 x 972	1601	1450	534	6700	329	1385	1200	534	6700	280		
1212	1220 x 1277	1601	1450	534	8800	342	1635	1450	534	8800	339		
1512	1525 x 1277	1901	1700	534	11000	412	1885	1700	534	11000	362		
1812	1830 x 1277	1926	1700	534	13200	400	1885	1700	534	13200	431		
1515	1525 x 1582	1901	1700	534	13700	421	1885	1700	534	13700	418		
1815	1830 x 1582	2101	1950	534	16500	475	2135	1950	534	16500	509		
1818	1830 x 1887	2351	2200	534	19800	588	2385	2200	534	19800	509		
2118	2135 x 1887	2371	2200	534	23000	588	2635	2450	534	23000	608		
2518	2440 x 1887	2851	2590	634	26000	948	2885	2590	534	26000	708		
2121	2135 x 2192	2851	2590	634	26500	974	2885	2590	634	26000	719		
2521	2440 x 2192	2851	2590	634	30500	974	2885	2590	634	30500	745		
2525	2440 x 2497	3101	2840	634	35000	1001	3135	2840	734	35000	1111		
2825	2825 x 2497	3351	3010	634	40000	1104	3385	3010	734	40000	1177		
3125	3130 x 2497	3351	3010	634	44500	1588	3635	3260	734	44500	1693		

Rotary heat exchanger removable from the side. Install empty sections upstream and downstream of rotary heat exchanger. Up to wheel diameter 2500 mm: single-part; larger wheel diameters in multiple parts (on-site assembly required). Calculation of recovery rate under dry conditions according to EN 308 +5 °C 0 % / +25 °C 0 %. Dimensions based on air velocity V1. Efficiency according to ERP 2018 minimum 73 %. V2A tray inclined according to VDI 6022 on request; 1" connection as standard; larger connections on request.

Humidification systems

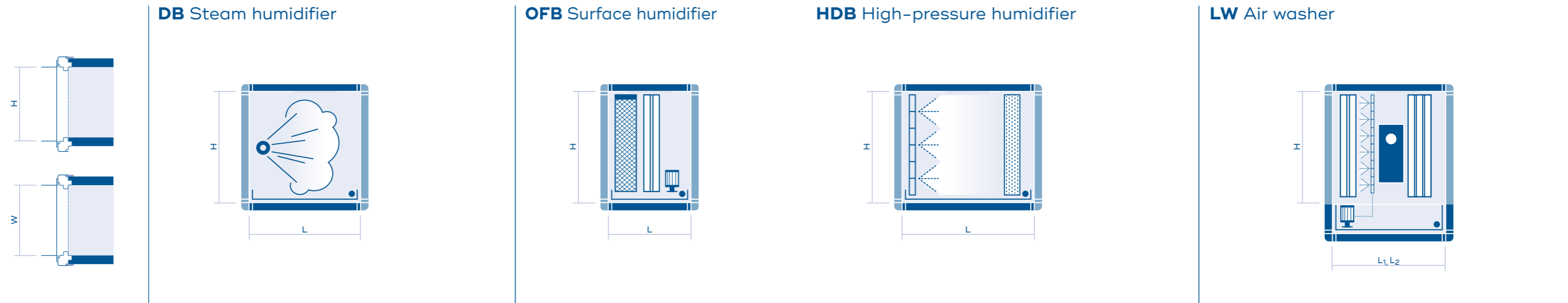

Size	Unit connection W x H (mm)	Low degree of humidification		Medium degree of humidification		High degree of humidification		Low degree of humidification		High degree of humidification		L ₁	L ₂		
		L	kg	L	kg	L	kg	L	kg	L	kg				
64	610 x 474	915	74	1220	93	1525	111	850	86	1500	100	1800	133	1220	1830
66	610 x 667	915	83	1220	104	1525	123	850	103	1500	117	1800	157	1220	1830
96	915 x 667	915	99	1220	128	1525	152	850	125	1500	150	1800	207	1220	1830
126	1220 x 667	915	117	1220	150	1525	178	850	147	1500	183	1800	256	1220	1830
99	915 x 972	915	115	1220	152	1525	179	850	151	1500	178	1800	253	1220	1830
129	1220 x 972	915	132	1220	173	1525	205	850	176	1500	211	1800	307	1220	1830
1212	1220 x 1277	915	149	1220	195	1525	230	850	204	1500	240	1800	359	1220	1830
1512	1525 x 1277	915	171	1220	222	1525	261	850	230	1500	277	1800	420	1220	1830
1812	1830 x 1277	915	190	1220	244	1525	287	850	256	1500	314	1800	481	1220	1830
1515	1525 x 1582	915	188	1220	244	1525	286	850	262	1500	308	1800	478	1220	1830
1815	1830 x 1582	915	213	1220	268	1525	314	850	290	1500	346	1800	544	1220	1830
1818	1830 x 1887	915	232	1220	291	1525	346	850	322	1500	379	1800	608	1220	1830
2118	2135 x 1887	915	255	1220	319	1525	380	850	352	1500	418	1800	682	1220	1830
2518	2440 x 1887	915	282	1220	349	1525	415	850	375	1500	458	1800	754	1220	1830
2121	2135 x 2192	915	285	1220	352	1525	417	850	386	1500	453	1800	751	1220	1830
2521	2440 x 2192	915	304	1220	376	1525	445	850	419	1500	493	1800	831	1220	1830
2525	2440 x 2497	915	325	1220	408	1525	474	850	451	1500	529	1800	906	1220	1830
2825	2825 x 2497	915	350	1220	434	1525	503	850	484	1500	583	1800	1014	1220	1830
3125	3130 x 2497	915	372	1220	465	1525	539	850	518	1500	625	1800	1099	1220	1830

VZA tray inclined according to VDI 6022. 1" connection as standard; larger connections on request. Low degree of humidification: 5 g/kg at outlet temperature 22 °C. Medium degree of humidification: 7 g/kg at outlet temperature 22 °C. High degree of humidification: 9 g/kg at outlet temperature 22 °C. The specified length refers to the humidification section; the length of the expansion section must be determined separately. Steam humidifiers available with electrodes (electric resistors) or heating resistors.

Calculation based on comb 150 mm including demister. Surface humidifiers must be accessible from both sides; if necessary, install empty sections of suitable length upstream and downstream of humidifier. All weights are empty weights. Separate models available for fresh water or recirculated water. For operating with recirculated water, install recirculating pump to supply humidifier cassettes. Water tank in stainless steel designed for gravity discharge. Humidifier cassette with stainless steel frame.

Low degree of humidification calculated with nozzle bar; high degree of humidification calculated with vortex generator panel. High-pressure humidifiers must be accessible from both sides; if necessary, install empty sections of suitable length upstream and downstream of humidifier. Pump station installed outside of unit.

Stainless-steel housing. Air washers must always be installed between flanges. Also available in insulated version. Air washers must be accessible from both sides; if necessary, install empty sections of suitable length upstream and downstream of humidifier. Weight on request.

Fans

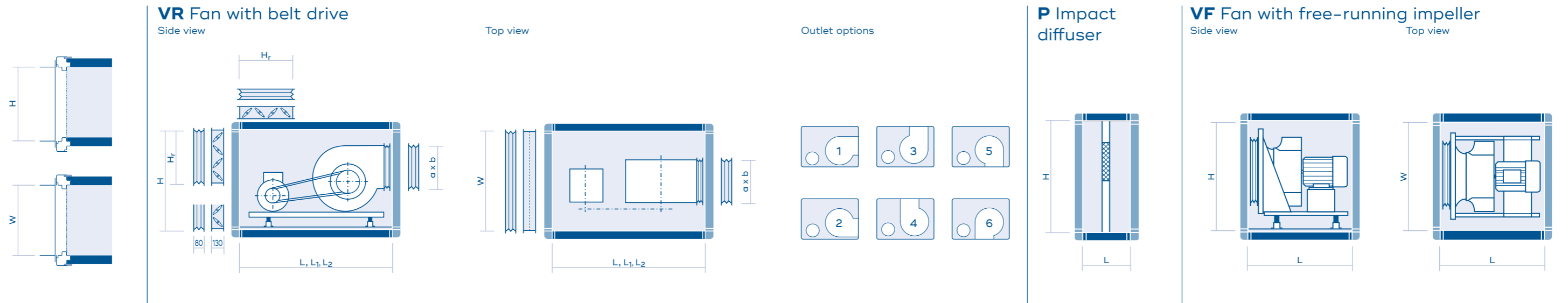

Size	Unit connection W x H (mm)	Outlet options														
		Size Fan type	Size Motor	L	H _r	a x b	max. kg	L ₁ (1-2)	L ₂ (3-6)	L	max. kg	Size Fan type	L	kg	L (with external frequency converter)	kg
64	610 x 474	160-215	71-112	724-915	230	205 ² -322 ²	53	915	915	152-458	25	200-225	640	90	890	110
66	610 x 667	200-250	71-112	610-1220	342	256 ² -322 ²	116	1220	1220	305-610	40	225-400	763	130	1013	150
96	915 x 667	225-280	71-132	610-1220	342	290 ² -361 ²	130	1220	1220	305-610	50	225-400	763	160	1013	180
126	1220 x 667	250-315	71-132	610-1220	342	322 ² -404 ²	148	1220	1220	305-610	52	225-400	763	180	1013	200
99	915 x 972	250-400	71-160	610-1525	455	322 ² -507 ²	219	1525	1525	305-610	59	225-630	957	240	1207	270
129	1220 x 972	315-450	71-180	915-1525	455	404 ² -569 ²	245	1525	1525	457-762	83	225-630	957	270	1207	300
1212	1220 x 1277	355-500	71-180	915-1830	678	453 ² -638 ²	323	1525	1830	457-915	112	225-800	1136	440	1386	470
1512	1525 x 1277	450-630	100-200	1220-1830	678	569 ² -800 ²	421	1525	1830	457-915	128	225-800	1136	470	1386	510
1812	1830 x 1277	450 - 630	112 - 200	1220-1830	678	569 ² -800 ²	449	1830	1830	457-915	137	225-800	1136	500	1386	540
1515	1525 x 1582	450-630	112-225	1220-2135	792	569 ² -801 ²	456	1830	2135	610-915	137	225-1000	1500	790	1750	830
1815	1830 x 1582	500-710	132-225	1525-2135	792	638 ² -898 ²	580	2135	2135	610-915	150	225-1000	1500	830	1750	880
1818	1830 x 1887	560-800	132-250	1525-2440	1017	732 ² -1007 ²	700	2135	2440	610-1220	217	225-1100	1810	1320	2060	1370
2118	2135 x 1887	630-800	132-250	1525-2440	1017	818 ² -1007 ²	781	2135	2440	610-1220	238	225-1100	1810	1370	2060	1420
2518	2440 x 1887	710-800	132-250	1830-2440	1017	915 ² -1007 ²	784	2135	2440	915-1220	254	225-1100	1810	1410	2060	1470
2121	2135 x 2192	630-900	132-280	1525-2745	1130	818 ² -1130 ²	1026	2440	2745	915-1220	254	225-1120	1419	1040	1669	1100
2521	2440 x 2192	800-1000	160-315	2135-3050	1130	1024 ² -1267 ²	1101	2745	3050	915-1220	270	225-1120	1560	1210	1810	1270
2525	2440 x 2497	900-1000	160-315	2135-3050	1242	1147 ² -1267 ²	1358	2745	3050	915-1220	382	225-1400	1761	1670	2011	1740
2825	2825 x 2497	900-1120	160-315	2135-3355	1242	1147 ² -1421 ²	1743	2745	3355	915-1525	385	225-1400	1761	1730	2011	1800
3125	3130 x 2497	900-1120	160-315	2135-3355	1242	1147 ² -1421 ²	1811	2745	3355	915-1525	406	225-1400	1761	1780	2011	1850

Fans with forward and backward curved impeller blades. Available with V-belt or flat belt. With standard single-speed or multiple-speed motors and PTC resistor; efficiency class IE3 or IE4. Fan housing galvanised or coated. ATEX VERSION - on request. Fan unit with vibration damping bearings as standard. Motor pull-out rail on request.

Galvanised as standard; stainless steel version on request. If there are other pressure-side components downstream, install impact diffuser downstream of fan.

Backward curved blades only. With standard single-speed motors and PTC resistor; efficiency class IE3 or IE4. EC technology: efficiency class IE4 or IE5. Minimum distance to other installed parts: at intake side $\geq 0.5 \times$ impeller diameter; at pressure side $\geq 1 \times$ impeller diameter. Fan unit with vibration damping bearings as standard. Motor pull-out rail on request.

Silencers

SD Silencer

Side view

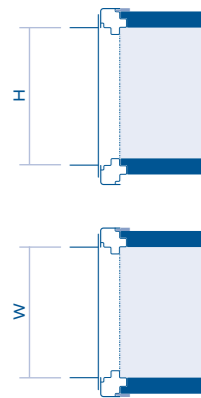

Top view

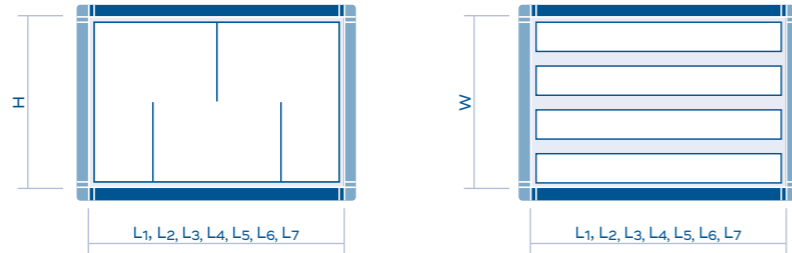

Empty sections

L Empty section

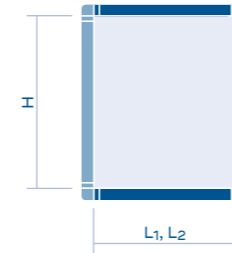

Examples of door locking systems

RAK Removable panel with locking clamp

RTS Service door with square key lock

RAV Removable panel with surface-mounted lock

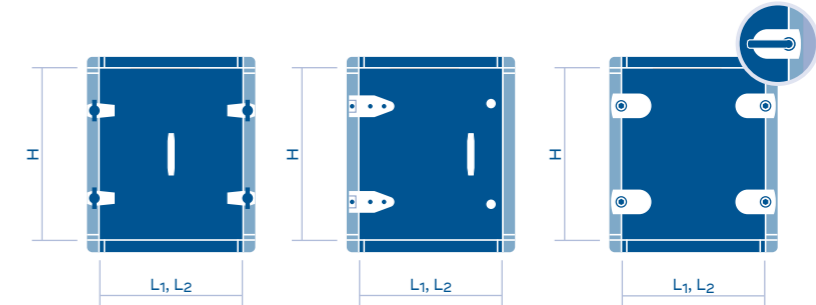

Size	Unit connection W x H (mm)	L1		L2		L3		L4		L5		L6		L7		L1	kg	L2	kg
		kg	kg	kg	kg	kg	kg	kg	kg	kg	kg	kg	kg	kg	kg				
64	610 x 474	500	70	750	100	1000	120	1250	140	1500	160					457	36	610	44
66	610 x 667	500	80	750	120	1000	140	1250	150	1500	190					457	40	610	48
96	915 x 667	500	100	750	150	1000	180	1250	210	1500	240					457	47	610	56
126	1220 x 667	500	130	750	180	1000	210	1250	250	1500	280					457	52	610	63
99	915 x 972	500	140	750	180	1000	210	1250	250	1500	280					457	53	610	63
129	1220 x 972	500	170	750	210	1000	260	1250	280	1500	340					457	58	610	71
1212	1220 x 1277			750	250	1000	300	1250	350	1500	390	1750	440			457	65	610	79
1512	1525 x 1277			750	340	1000	400	1250	450	1500	510	1750	570			457	71	610	86
1812	1830 x 1277			750	380	1000	470	1250	530	1500	600	1750	660			457	77	610	94
1515	1525 x 1582			750	380	1000	450	1250	510	1500	580	1750	640			457	77	610	95
1815	1830 x 1582			750	430	1000	520	1250	590	1500	670	1750	740			457	83	610	102
1818	1830 x 1887					1000	580	1250	660	1500	740	1750	820	2000	920	457	89	610	110
2118	2135 x 1887					1000	640	1250	730	1500	820	1750	910	2000	1020	457	95	610	120
2518	2440 x 1887					1000	710	1250	800	1500	900	1750	1000	2000	1110	457	103	610	127
2121	2135 x 2192					1000	710	1250	800	1500	900	1750	990	2000	1150	457	103	610	127
2521	2440 x 2192					1000	770	1250	880	1500	980	1750	1090	2000	1260	457	110	610	135
2525	2440 x 2497					1000	840	1250	950	1500	1060	1750	1220	2000	1360	457	116	610	151
2825	2825 x 2497					1000	950	1250	1080	1500	1210	1750	1390	2000	1550	457	122	610	161
3125	3130 x 2497					1000	1030	1250	1170	1500	1310	1750	1500	2000	1670	457	130	610	168

Removable from the side. Galvanised frame, with glass silk cover as standard; coated or in stainless steel (optional). Minimum distance to installed parts at intake side: 1 x splitter width (exception: filters). Minimum distance to installed parts at outlet side: 1.5 x splitter width.

Empty section < 350 mm only as detachable maintenance panel; larger sections available with various locking systems (see page 38). Doors with sight glass: L min. = 400 mm.

Door locking systems

Since hygiene standards such as VDI 6022 have become best engineering practice, we recommend installing empty sections upstream and downstream of all components that require maintenance and/or cleaning. This includes in particular filters and heat exchangers. Empty sections come with detachable

maintenance panels or doors that allow for easy access for cleaning, inspection and servicing. Depending on the available space around and inside the air handling unit and the size of the installed component that requires regular maintenance, you can choose from a range of WEGER locking systems.

REMOVABLE PANEL WITH LOCKING CLAMP (RAK)

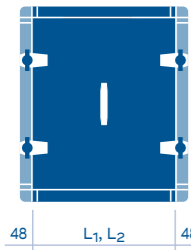

The locking clamps attached to the housing frame are pressed against the panel by turning the wing screws. This system is normally only installed with detachable panels, and in particular behind narrow components such as demisters and frost protection frames that can be pulled out. It is also useful for panels providing access to cassette filters that can be pulled out from the side.



REMOVABLE PANEL WITH SQUARE KEY LOCK (RAS)

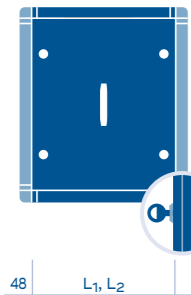

This locking system has also been designed primarily for detachable panels. It is operated with a square key that turns the lock bolts. The square key used to operate the mechanism is classified as a tool, so that the locking mechanism meets the general safety rules and requirements. The system is therefore primarily used in housing sections containing potentially hazardous components such as fans, or in areas where there is not sufficient space.



REMOVABLE PANEL WITH SURFACE-MOUNTED LOCK (RAV)

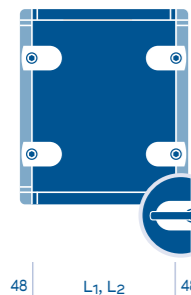

This version with special surface-mounted locks for is a great alternative to the locking systems described above. To achieve the full airtight sealing effect, these types of locks allow only for minimum tolerances, and must therefore be precision-installed.

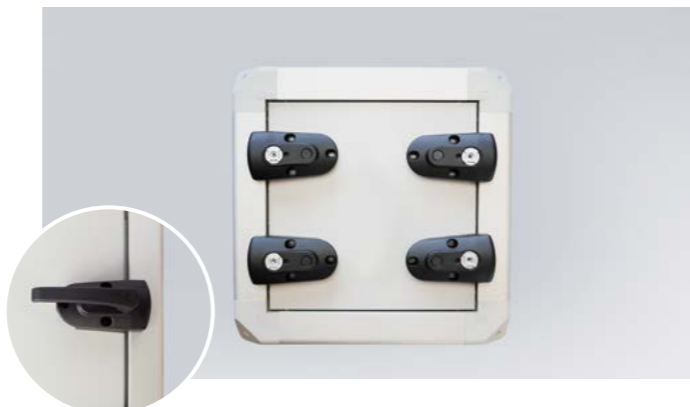

SERVICE DOOR WITH HINGE (RTH)

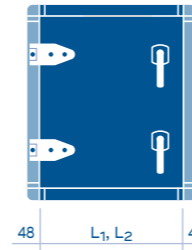

This version comes with an ergonomically designed handle acting as a turn lock. It is recommended for doors in maintenance and empty sections where tool-free access to the inside of the AHU is required. Do not choose this type of locking mechanism for access doors to hazardous components.



SERVICE DOOR WITH SQUARE KEY LOCK (RTS)

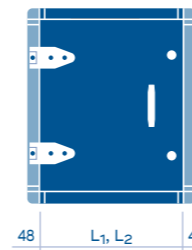

The function and locking method is similar to system RAS. In addition to the locks, the door features two specially designed hinges with which the door position can be fine-tuned after installation, namely in and out, up and down for adjusting the door push-on pressure.



SERVICE DOOR WITH SURFACE-MOUNTED LOCK (RTV)

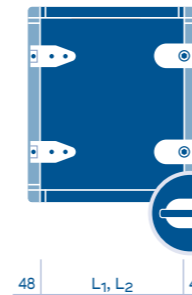

This system with special surface-mounted locking mechanisms is an alternative to the above versions. As the door is airtight when closed, the locking devices must be precision-mounted and adjusted during commissioning.



Base frames & feet

Depending on the application and actual site conditions, it might be necessary to place the AHU on a base frame. Base frames improve the stability of the unit, and make sure that it is accessible even if after snowfall. In units equipped with a siphon, the additional height ensures that there is sufficient system pres-

sure. The base frame and the unit frame can be fitted with fixed or adjustable feet, or a combination of these two types of feet. Adjustable feet are often installed to compensate for uneven floors. All base frames and feet are available in stainless steel, or with a special powder coating for extra protection against corrosion.

1. BASE FRAME

- a** C-profile with open side facing outwards, galvanised, H=80 mm, W=50 mm, wall thickness=3 mm; suitable for small to medium-size units (max. outer frame dimensions: H=2000, W=2000, L=3400 mm)
- b** C-profile with open side facing outwards, galvanised, H=120 mm, W=60 mm, wall thickness =4 mm; available in all system sizes
- c** C-profile with open side facing outwards, galvanised, H (adjustable) = 80-700 mm, customised construction, dimensions depending on unit size (W=50/60 mm, wall thickness =3/4 mm)



2. SIMPLE BASE FRAME WITH ADJUSTABLE FEET*

- a** adjustable feet with plastic base, attached to base frame, H=70 mm, adjusting range = ± 15 mm
- b** adjustable feet with galvanised base, attached to base frame; integrated vibration decoupling, H=70 mm, adjusting range = ± 15 mm
- c** adjustable feet with plastic base, attached to base frame, H=115 mm, adjusting range = ± 20 mm
- d** adjustable feet with galvanised base, attached to base frame; integrated vibration decoupling, H=115 mm, adjusting range = ± 20 mm

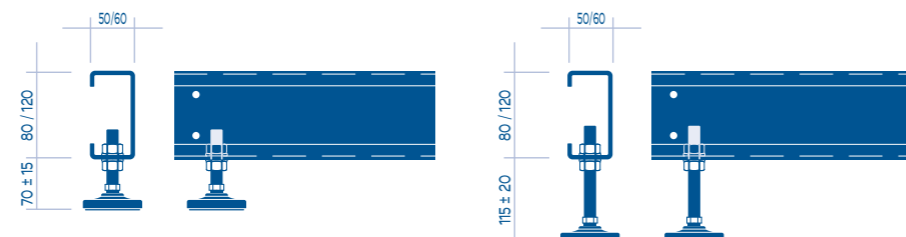

3. BASE FRAME WITH FIXED FEET MADE OF STEEL*

- a** Fixed feet made of steel mounted to base frame, standard height=130 mm
- b** Fixed feet made of steel mounted to base frame, standard height=190 mm
- c** Fixed feet made of steel mounted to base frame, standard height H (variable) 80-700 mm (based on customer specifications and unit size)

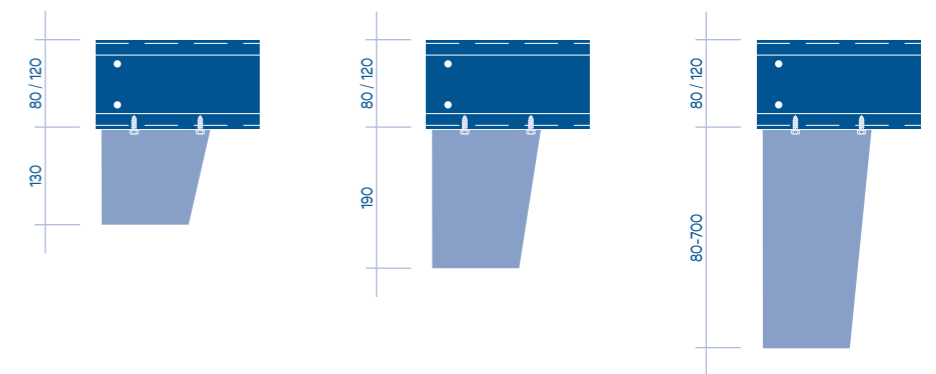

4. BASE FRAME WITH FIXED FEET MADE OF STEEL AND ADJUSTABLE FEET*

- a** fixed feet made of steel mounted to base frame, with adjustable feet (for versions see section 2.), standard height = 130 mm
- b** fixed feet made of steel mounted to base frame, with adjustable feet (for versions see section 2.), standard height = 190 mm
- c** fixed feet made of steel mounted to base frame, with adjustable feet (for versions see section 2.), H (variable) = 80-700 mm (based on customer specifications and unit size)

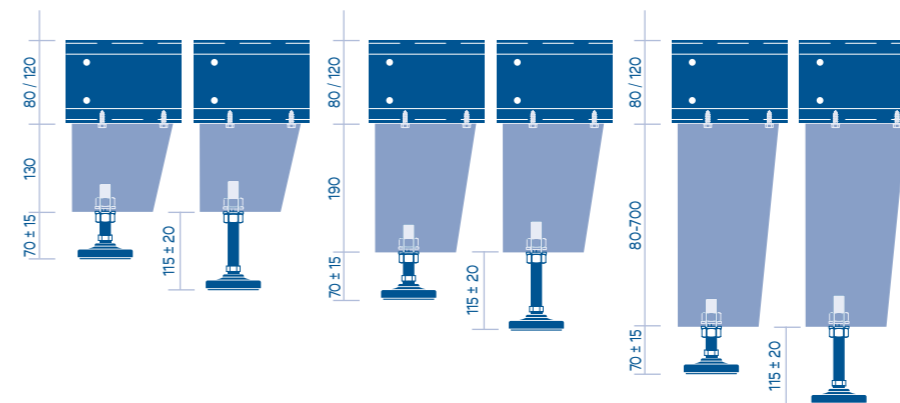

* The maximum permissible distance between the feet is 1500 mm!

Multi leaf dampers

Air-control dampers are used to control the air flow in air handling units, down to airtight shut-off. We produce dampers of other dimensions on request.

Dampers consist of:

- Sturdy, rectangular aluminium profile frame with 30 mm wide flange
- Torsion-resistant aluminium louvres in lightweight construction
- Easily replaceable lip seals
- Plastic cogs for precision control; maintenance-free, integrated into frame and thus protected against contamination and damage
- Easily dismountable components; no riveted connection or welded joints
- Components free of silicone

The angle of the louvres is indicated by a notch in the cover cap of the positioning axis that is visible from the outside. The damper is suitable for installation at both ends of the air flow profiles (channels).



Damper leakage and damper housing leakage have been tested by TUEV Nord in a number of sample sizes and are certified as follows:

- Damper leakage when air-control damper is closed according to EN 1751: class 2-4, depending on size and model
- Damper housing leakage according to EN 1751: classes A + B, depending on size and model, temperature-resistance in continuous mode operation -30°C to +90°C, short-term resistant up to +110°C
- For channel pressures up to 1000 Pa
- By making minor modifications (e.g. mounting closed-pore sealing elements at louvre bearings), the damper can be upgraded to meet the DIN 1946 hygiene requirements

OPTIONAL EQUIPMENT AND ACCESSORIES

- Manual locking element to secure dampers in place
- Electric actuators (opening/closing or modulating, with or without spring return)
- Extra corrosion protection by additional eloxal coating
- Dampers in stainless steel with special external bars connecting the louvres (opposite or parallel)

SPECIAL DESIGNS AND ACCESSORIES

- Versions in standard or stainless steel with brass or stainless-steel bushes for operation in ATEX environments
- Explosion-proof actuators to open and close ATEX dampers
- Versions in galvanised steel and stainless steel, temperature-resistant from -40°C to +200°C
- Pneumatic actuators to open and close air-control dampers
- Dampers with insulated frames equipped with self-adhesive insulating material and anti-stick finish
- Electric heating elements with defrost function integrated into hollow profile fins



Smart detail: integrated gear with hygiene cover in airtight damper version conforming to DIN EN 1751 class 4



Positioning axis with mark indicating louvre positions

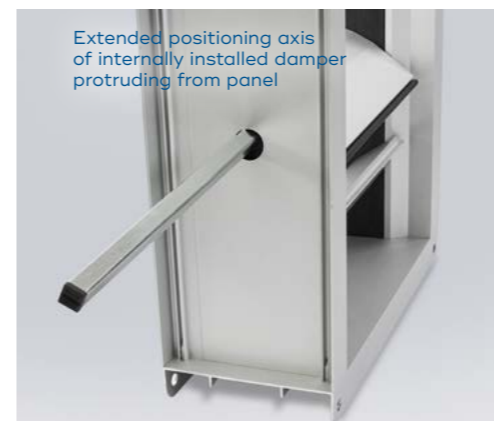

Extended positioning axis of internally installed damper protruding from panel

OPTIMISED TORQUES

The table below shows the recommended torques for safe opening and closing. The torques applied during closing push the louvres firmly against each other so that there are no gaps, ensuring that the guaranteed leakage rates for closed dampers are met. The two servo motors for opening/closing and modulating are available with or without spring return.

		Torque (Nm)						
		2	4	5	10	20	30	40
Damper surface (m ²)	0,4							
	0,8							
	1							
	2							
	4							
	6							
	8							

PRESSURE LOSS AT DAMPER AS A FUNCTION OF FACE VELOCITY

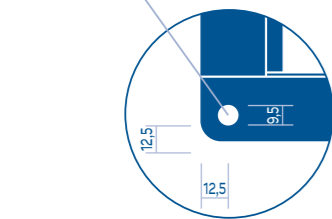
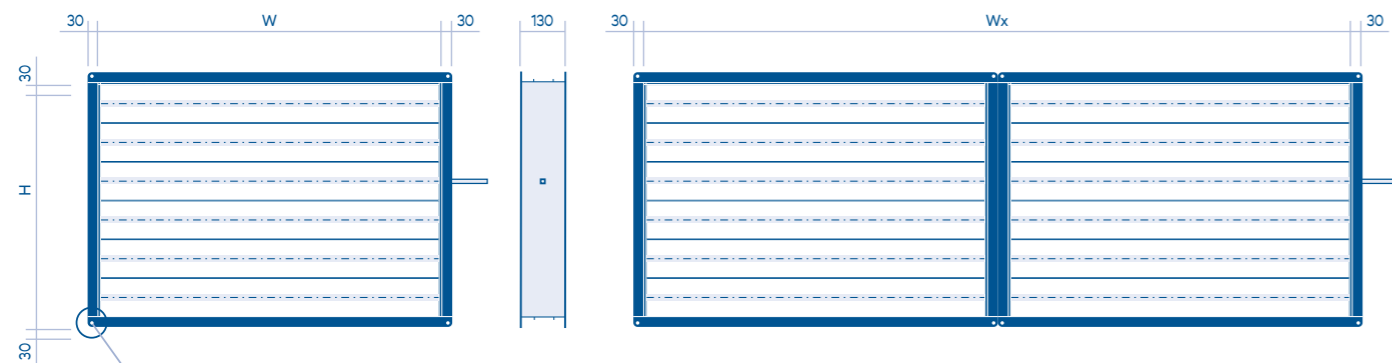
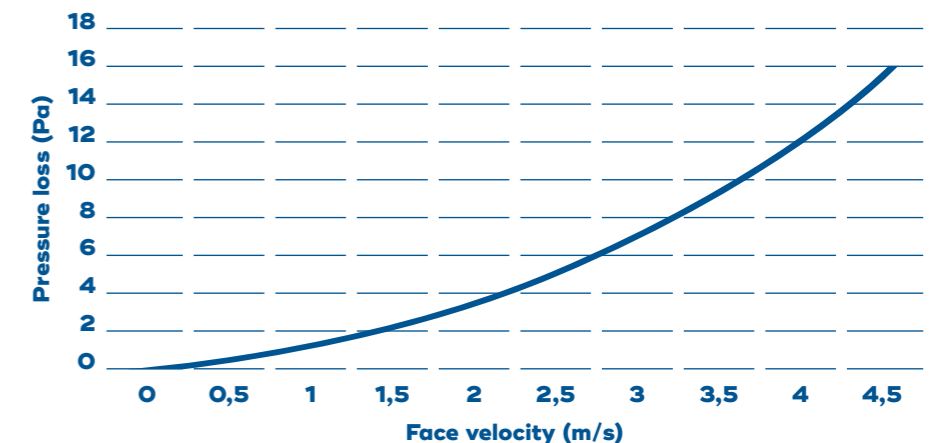

WIDTH (W)
As single damper up to 1830 mm. For greater widths, the dampers are divided vertically.

HEIGHT (H)
As required. Airtight dampers higher than 1280 mm are divided horizontally.

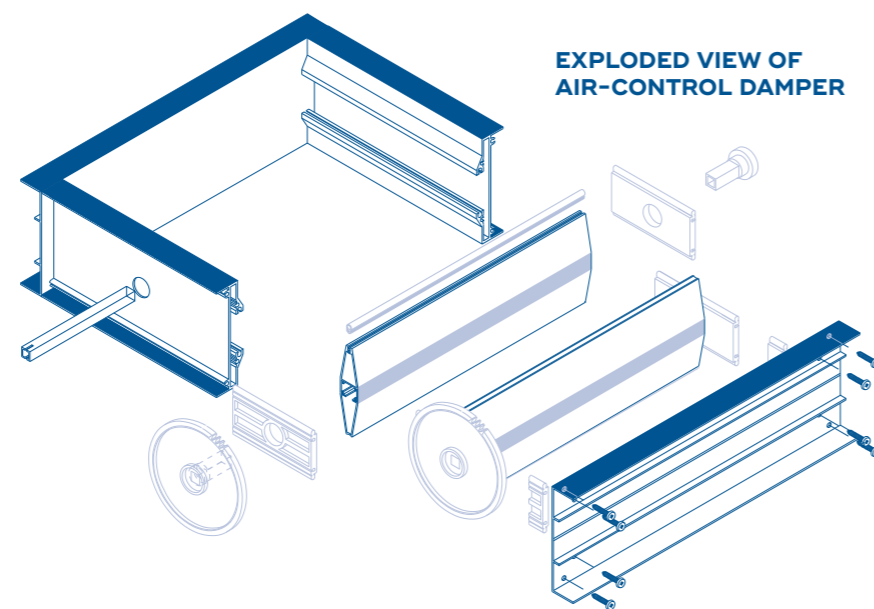

EXPLODED VIEW OF AIR-CONTROL DAMPER

Weatherproof executions

In many modern buildings, the technical equipment needs to be installed outdoors. That is why many air handling units are placed on the roofs of buildings. The units and products from WEGER are of course available in versions for outdoor installation. As always, you have the option to choose between various designs and concepts.

The weatherproof air handling units from WEGER are factory-fitted with an aluminium roof (AlMg3) with a 100 mm overhang on all sides as standard. This overhang may be extended, should it be necessary. To prevent rainwater ingress through the mechanical joints between the housing frame and the panels, WEGER has developed special plastic clamping bars. These bars feature co-extruded sealing strips at both sides. The soft strip section on the inside of the bar provides a watertight seal to the panel. The strip section at the outside protects the clamping bar edge against damage from impact. These bars and strips ensure that fixed panels can be opened and closed without the need for electrical tools, as the clamping bar can be removed easily with a crowbar and hammer without causing any damage. For more information, please refer to the operating and maintenance instructions.

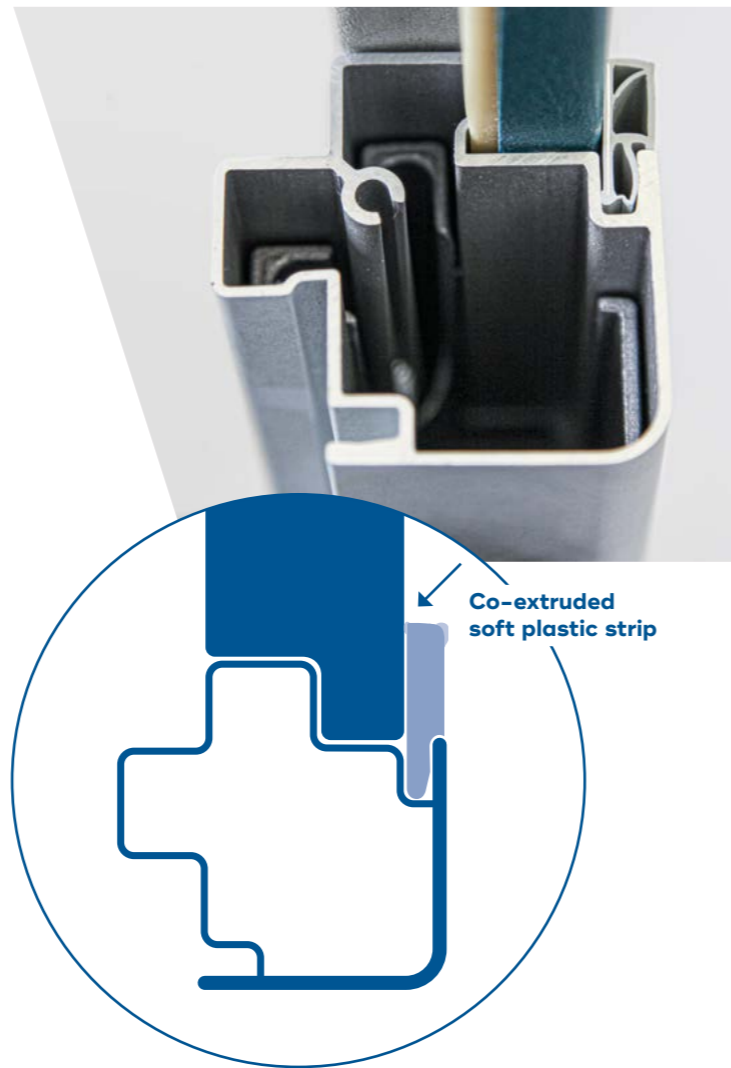

INSTALLATION INSTRUCTIONS

According to DIN EN 13053 (6.2) and VDI 38031 (5.1) air handling units installed on roofs must not be used for structural functions or as part of the roof! Air handling units are designed and produced according to standards for machinery and do not necessarily meet the requirements of building construction standards. This means that AHUs must never be used for structural roof functions such as sealing or thermal insulation.

The roof under the unit must always be constructed to perform all relevant functions with regard to structural strength, tightness and insulation. Like any other machine, the air handling unit must be placed on suitable, load-bearing elements on the roof. The load-bearing elements carrying the AHU might consist of steel structures, paving slabs or other suitable elements.

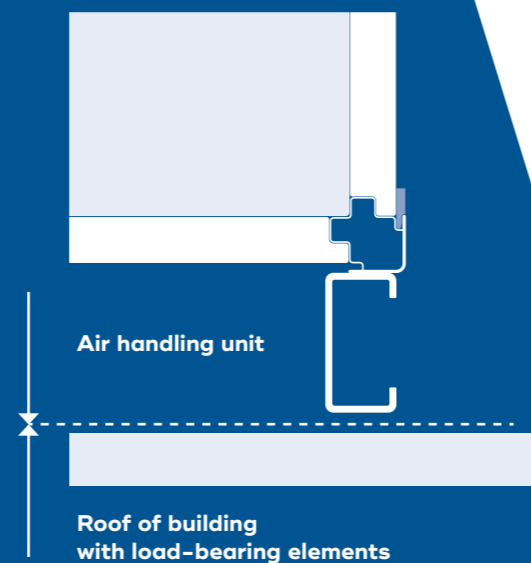

FLAT ROOF

Basic model, with insulating strip at the centre below the aluminium roof for a slightly convex roof curvature to prevent puddles

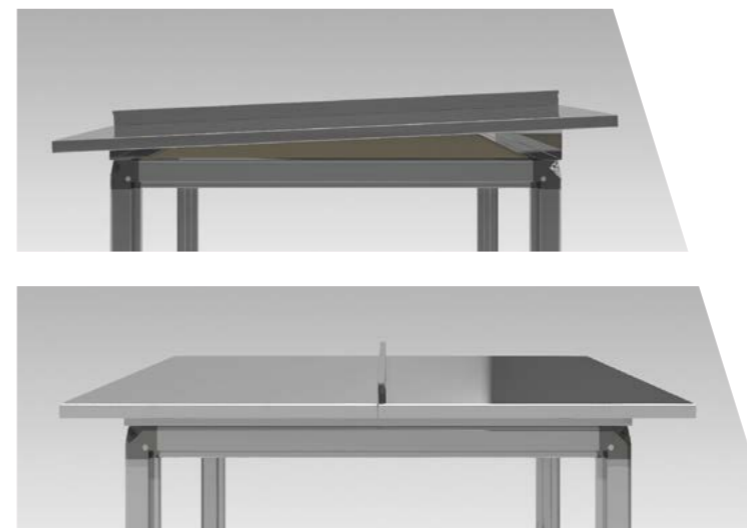
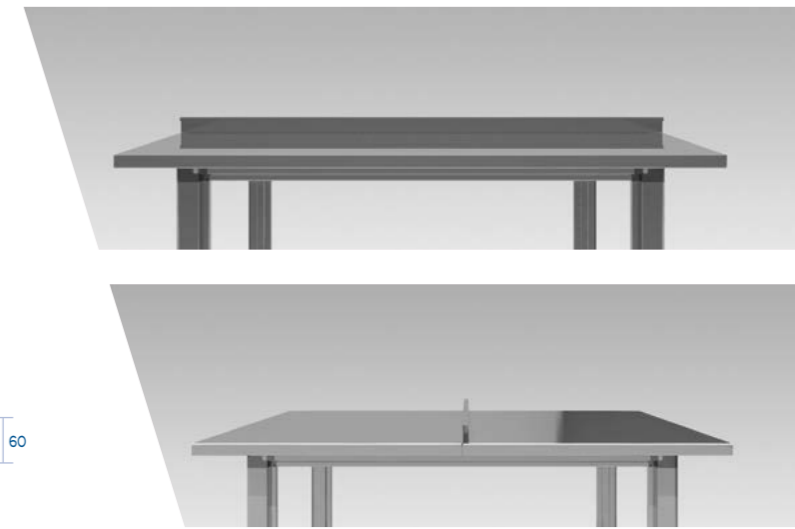
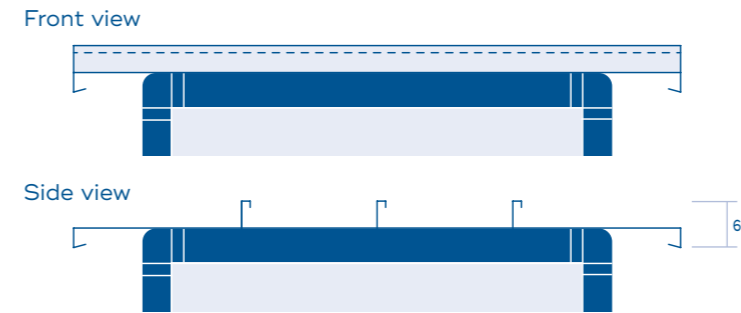

SINGLE PICHED ROOF

Inclined to operating or rear side, as required by operator

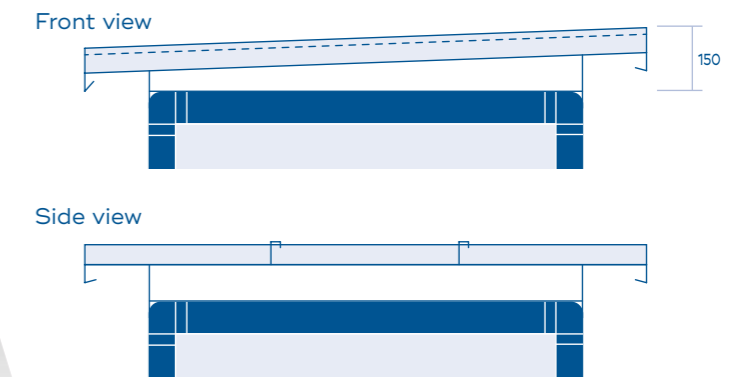

DOUBLE PICHED ROOF

Roof pitched at both sides, with perforated front panels for ventilation; roof available with double-wall insulation

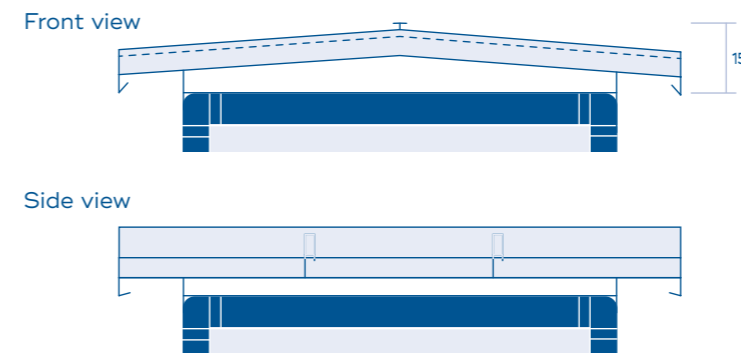

Wall and ceiling fixtures

Depending on the unit weight, dimensions, general site conditions and the positions of the maintenance panels, air handling units might be mounted on walls and ceilings. We offer a range of fixtures for such installations. Please note that only the fixtures at the AHU side are covered in our supply contract,

and the actual installation on site is the responsibility of the customer. Therefore, these fixtures are not included in the scope of delivery. WEGER shall therefore not be liable for the correct installation and fixture of supplied air handling units.

CEILING SUSPENSION TABS

These tabs have been specially designed for small units that can be suspended from the ceiling. The WEGER ceiling suspension tabs are mounted to the upper part of the housing frame. They are shipped as loose or fully mounted parts and are made in galvanised steel as standard. Our ceiling suspension tabs are also available in stainless or powder-coated steel for extra corrosion protection.

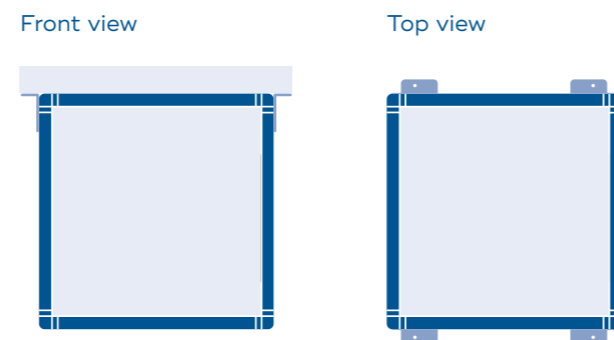

CEILING SUSPENSION BRACKETS MOUNTED TO BASE FRAME

With this system, the weight of the air handling unit is carried by the base frame, to which specially designed 90° brackets are mounted. This system allows for rigid or vibration-isolated suspension of the AHU by means of threaded rods. The brackets are made in galvanised steel as standard and shipped as kits. For extra corrosion protection, we offer powder-coated brackets. The bracket kit consists of the actual bracket, the counter-mount, the screw set and the base frame.

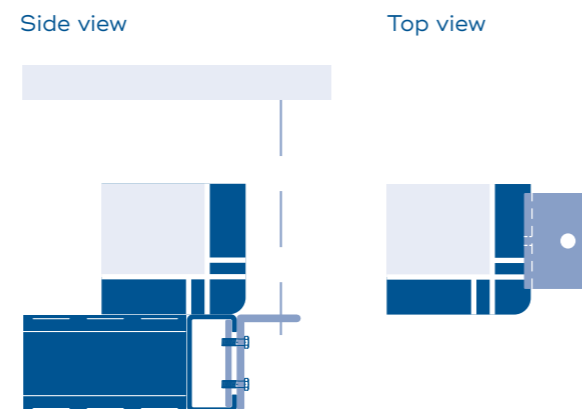

CEILING SUSPENSION WITH ATTACHMENT TO EXTENDED BASE FRAME ELEMENTS

With this system, the weight of the air handling unit is carried by the base frame. Instead of using brackets, the base frame is extended to protrude from the unit, and the threaded suspension rods are screwed to these protruding sections. The extended base frame is available in two versions. For details, see versions 1.a and 1.b on [page 40](#) in this catalogue, chapter [Base frames & feet](#). The base frame is made in galvanised steel as standard. For extra corrosion protection, we supply base frames in stainless or powder-coated steel.

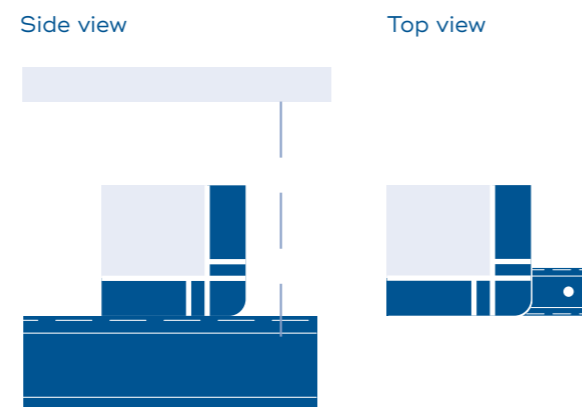

Quality

To make a high-quality product, not only the materials but also the production processes must meet the most stringent standards. WEGER wants to supply the global market with innovative air handling equipment and units. To achieve this goal, we have adopted a business philosophy based on the following core principles:

- We offer our customers top-quality and technically advanced solutions.
- We fulfil customer orders in an efficient manner, coming up with innovative solutions.
- Our core competences are the planning, organisation production and installation of air handling equipment and units.
- Flexibility and customised designs demonstrate the capabilities of our organisation.
- We strictly comply with all guidelines relating to public procurement contracts such as GVD 231, and review our organisational model on an annual basis.



Our capabilities and commitments are reflected in our products. That is why we operate a certified management system and have our products tested and evaluated by independent bodies (TUEV, Eurovent, etc.) on a voluntary basis. Our products and operations meet the requirements of ISO 9001:2015, and conform to all relevant standards and regulations in connection with health, safety the protection of the environment and energy efficiency (ISO 45001:2018, ISO 14001:2015).

As our products all work with air on which all life depends, the protection of the environment is of course an issue particularly close to our heart. We work hard to minimise our carbon footprint and have introduced a number of measures and technologies that enable us to become ever more climate-friendly.

- Photovoltaic plants installed on the roofs of many of our premises supply the electricity we need in production.
- Disposable pallets are used as biomass for the heating of our factory halls.
- We are directly involved in schemes for the certification of energy efficient products (e.g. EEF label of RLT Herstellerverband e.V.).
- We carry out life cycle analyses of our products, covering everything from planning and production to operation and disposal.
- We dispose of all waste in a safe manner, and work closely with suppliers and customers to minimise waste.
- We invest in renewable energy to keep greenhouse gas emissions as low as possible.
- Base on our certified systems for quality management (ISO 9001:2015), environmental management (ISO 14001:2015) and occupational health and safety management (ISO 45001:2018), we have put in place an integrated management system that guides our business decisions, protecting our employees, suppliers and customers.



Compact units

Apart from industrial air handling units, there is a huge demand for comfort ventilation systems for offices, retail premises, schools, lecture halls, event venues, public buildings and residential homes. To cater for this market, WEGER has developed various compact units that include models and sizes for virtually all needs and meet the highest standards with regard to product quality and flexibility. We use state-of-the-art air handling technology even in our smallest units, so that you can always avail of advanced functions and features.

The expertise and experience acquired since the foundation of our company in 1977 enabled us to come up with preconfigured compact units that meet the demands of our customers and are second to none when it comes to quality, technology and hygiene. Our compact units are true plug & play systems combining top-quality components with the unrivalled know-how of WEGER. By opting for our intuitive Imperia 51 control system, you can upgrade your compact unit with one of the most advanced control solutions currently available on the market.

Goliath

The giant among our compact units

The Goliath is the ideal model for air flows between 500 m³/h and 4500 m³/h, offering excellent quality and flexibility. The units come in a range of designs, and the positions of the connections and control devices can be chosen freely. The built-in counterflow plate heat exchanger combines high efficiency with minimum leakage. The intelligent control unit makes servicing and operation easy and also assists operators in optimising the interaction between sub-units, air, mediums and measuring and control hardware.



Sairios

Flexible all-rounder for home ventilation

The smallest of our compact units covers a performance range up to 550 m³/h. It is therefore the ideal model for best air quality and energy efficiency in residential units, offices, meeting rooms and similar premises. With an efficiency rating of more than 90 % at the optimum operating point, the Sairios is one of the most cost- and energy-efficient solutions for controlled ventilation at home.



Goliath Top 4

Open top, open mind

All air connections of the Goliath Top 4 are located at the top of the unit, hence its name. Thanks to this feature, the Goliath Top 4 has a very small overall footprint and is therefore ideal for building renovation and other projects where space is limited. Many innovative details such as the control unit installed outside the air stream make installation easy. All subunits are seamlessly integrated for smooth operation across all interfaces. The built-in heat recovery system (>90 %) guarantees high energy savings.



Diamant

The jewel among compact ventilation units

The perfect top-grade solution for ventilation in non-industrial environments. State-of-the-art technology guarantees minimal energy consumption, excellent efficiency and a long service life, combined with low operating costs and intuitive control. This compact unit has long become a best-seller. Thanks to a range of add-on components, the DIAMANT can be configured for 800 to 15,000 m³/h, thus catering for virtually all applications.



Aquawell

Wellness made easy

In indoor pools, air humidity is one of the key factors of comfort and wellness. The Aquawell series from WEGER has been specifically developed for installation in spas and public swimming pools. Sophisticated control mechanisms guarantee efficient energy management under all operating conditions. Aquawell monitors all relevant parameters for instant, real-time adjustment. The series has been designed for maximum protection against corrosion, eliminating any risk of fungal growth.



Special components

In addition to a wide range of more or less “mandatory” components for the configuration and installation of air handling and ventilation units, WEGER offers products that are not strictly part AHU standard equipment but come in handy in certain situations. One of the cornerstones of WEGER’s success has been the company’s ability to think outside the box and to meet customer requirements as they arise. WEGER has the know-how and expertise to develop

and produce components for highly specialised applications. Our employees have the skills and resources to come up with innovative technical solutions for specific tasks and operating environments. In this chapter, we wish to present a number of special components that were designed following a specific request, but have since been developed further for general use in our AHUs.

Accubloc

Efficient temperature and moisture exchange

This regenerative energy recovery system combines a static matrix block with an intermittent damper function for extra efficient temperature and/or moisture exchange. It has a temperature efficiency rating of up to 95 %. In certain cases, it is even possible to omit the downstream heating register. The Accubloc system is frost-proof and guarantees minimum exhaust air transfer.



Maintenance platform with stairs

Safe and easy access to maintenance platform

Units measuring 1.8 m or more in height can be equipped with maintenance platforms for safe and easy filter change and similar tasks. The platform is reached over stairs with handrail that are permanently installed. For extra safety, the steps and the platform are fitted with diamond plates while the overall structure is made from high-strength aluminium and thus not affected by corrosion.



Indirect heating

For any heating output

A modular combustion chamber burning oil or gas produces the heat for the air handling unit. The combustion chamber is separate from the AHU and can be installed directly where the heat is required. Thanks to modern production technologies and the use of top-quality materials, our indirect heating systems conform to all relevant standards and offer outputs from 20 kW to 2 MW.



Folding maintenance platform

Safe maintenance platform taking up no space

For large-size units, we offer a folding grille platform that forms part of the AHU and facilitates the changing of filters high up in the unit.



Direct heating

Advanced burner elements

The gas-fired flat flame burner is a modular unit and is positioned directly in the air flow, so that there is no need for a combustion air fan. Its key features are a control range up to 35:1, a combustion efficiency of 100 %, clean burning and a constant temperature. It can be run with any combustible gas.



Special applications

As a manufacturer of versatile air handling units, we are known for successfully mastering projects whose realisation initially appears quite impossible. Apart from standard air handling and ventilation tasks, we often need to consider the requirements of other processes as well as specific site conditions. Sometimes, there is no ready-made solution available in the market, and customers turn to WEGER, as we are renowned for taking their needs seriously, coming up with designs that exceed their expectations. Our engineers spend many hours thinking outside the box, trying out new ideas and developing new

solutions that work. They can of course rely on the expertise bundled in their teams, but also on the courage of the founding family who never shied away from a challenge. Over time, WEGER developed new technologies and designs that quickly moved from prototypes to series production. As far as our units for special applications are concerned, there are no limits in what we can do for you with a custom-engineered solution. In this chapter, we wish to showcase a number of solutions for special applications that we have developed to date.

Units made in plastic

The plastic materials we use meet the most stringent requirements as regards tightness, resistance against corrosion and fire safety. They are approved for hygiene applications according to VDI 6022 and meet the requirements for energy-relevant products under the EED. The single-side high-performance radial fan made in plastic is driven by a motor that is located outside the air stream. Its speed is controlled by a frequency converter, while the motor is protected by a PTC resistor. This unit is ideal for laboratories.



Units for test benches

WEGER successfully developed a measuring and testing system for brake test benches that can be run under virtually all climate conditions at temperatures from -40°C to $+70^{\circ}\text{C}$, and a relative air humidity from 1% to 99%. Functions include: redundant refrigeration with defroster; cooling using environmentally friendly refrigerants; humidification, high-temperature heating, spark protection, recirculated air and flushing air handling. The unit is shipped as a turn-key system.



Units of special customisation

When it comes to renovation and retrofitting projects, it is crucial that the new AHU fits into the available space, while energy efficiency and quality must not be compromised. The versatile frame constructions from WEGER enable the company to devise flow-optimised units in any shape and form, at minimum extra costs. Over the years, we have successfully implemented various projects with units in the shape of an L, U and S.



Units for greenhouses

Greenhouses are commercial premises for the production of plants and crops and therefore need fine-tuned air-conditioning and ventilation. The design of the air handling unit takes into account all critical factors and complex ambient parameters, as well as changing requirements along the crop growing cycle. Our solutions reduce the risk of crop failure, boost yields and minimise operating costs.



Units for high external pressure

When an aeroplane is being cleaned, the turbines are not running. That is why the cabin ventilation system must be connected to an external AHU. Given the size and length of the lines, the pressure to be produced in such units is well above the normal range. In extreme cases, it must be 10,000 Pascal. WEGER has developed a special frameless, high-strength unit for this task. Before it leaves the factory, the system undergoes a fully documented pressure test and acceptance procedure.



High-temperature units

Foundries, industrial bakeries, roasting plants and similar facilities produce a lot of heat. To process air with a temperature of up to 350°C, WEGER offers a special high-temperature model with heat-resistant seals and modified heat exchangers for optimised energy recovery.



Unit-inside-unit system

To meet the most stringent acoustic and thermal decoupling requirements, we install the actual AHU inside a special empty housing, using advanced decoupling elements and technologies. This results in a unit inside a unit, whereby large access doors allow for easy maintenance and cleaning. Unit-inside-unit systems are often used in cinemas, concert halls and of course in acoustic labs.



Hall ventilation units

In large industrial halls, it is often more efficient and cost-effective to run decentralised ventilation units. The air quality at the various workplaces can differ greatly and is often difficult to control, as it depends on many factors such as room height, machine density, workers per space and shift schedules. For mixed and layered ventilation, we offer recirculation units that can be vertically mounted on hall columns. They thus take up little space and do not obstruct work.



Antimicrobial coating

BACSTOP is an innovative antimicrobial foil coating developed by WEGER that offers effective protection even against multi-resistant germs. Its long-term effectiveness has been certified by independent bodies according to ISO 22196: 2007 / JIS Z 2801:2006 / ASTM E 2180-07. BACSTOP becomes active the moment conditions become favourable for the growth of bacteria, fungi and algae.



GFRP units

In meat factories, air handling units must be cleaned and sterilised every 14 hours with highly aggressive chemicals. Conventional hygiene units simply cannot withstand such treatment. That is why WEGER offers AHUs that are clad in glass-fibre reinforced plastic (GFRP) panels. These panels are resistant to disinfectants and can be easily cleaned to the required hygiene standard.



Fuel gas extraction systems for aeroplanes

WEGER offers a mobile unit that makes the refuelling of aeroplanes safer and easier. During refuelling, the escaping combustible air is safely extracted rather than released into the environment. Our extractors are protected by earthing and designed as ATEX devices.



Software

When designing an air handling unit, one needs to first of all choose the right components. Each component must then be positioned in exactly the right place and correctly configured for the actual application. In other words: designing an efficient AHU is a highly complex task, as there are many factors and parameters to be taken into account: First of all, there are the characteristics of the building and its use. Then we need

1 WEGER UNIT CONFIGURATOR (WGK)

This program developed by our own IT team is the main tool we use for the calculation of air handling units. Apart from detailed unit visualisations, it provides all the data needed for the compilation of the technical documentation. In addition, the software processes meta data for master structures and supports data export in various formats, keeping pace with the ever progressing digitisation in building technology. The Weger Unit Configurator goes a step further however, as it contains a preconfiguration database that makes the input of data not just much easier but also less time-consuming. Standard units can thus be visualised with all the relevant details, followed by an accurate cost calculation. The software features of course a plug&play interface to ICA technology for seamless data transfer and the generation of accurate technical documents.

to consider the installation site, the altitude above sea level and the resulting air pressure, the average temperatures over the year, the operating hours, and much more. Only when all these factors are known can we actually devise a unit that meet all requirements. The most efficient way to make these calculations is by means of software that processes all these parameters and returns a number of possible solutions.

2 COMPACT AHU CONFIGURATOR

This plug-in for the Weger Unit Configurator is particularly useful for the selection and configuration of our compact units of the Sairios, Goliath, Goliath Top4, Diamant or Aquawell series. It uses the power of the Weger Unit Configurator for the compilation of project-specific documents including fully priced offers. The program comes with an intuitive graphic user interface so that it takes only a few steps and inputs to find the best possible solution for a specific project. The Compact AHU Configurator returns a simplified unit diagram, a list of components, optional elements and suitable accessories as well as all relevant technical data and prices.

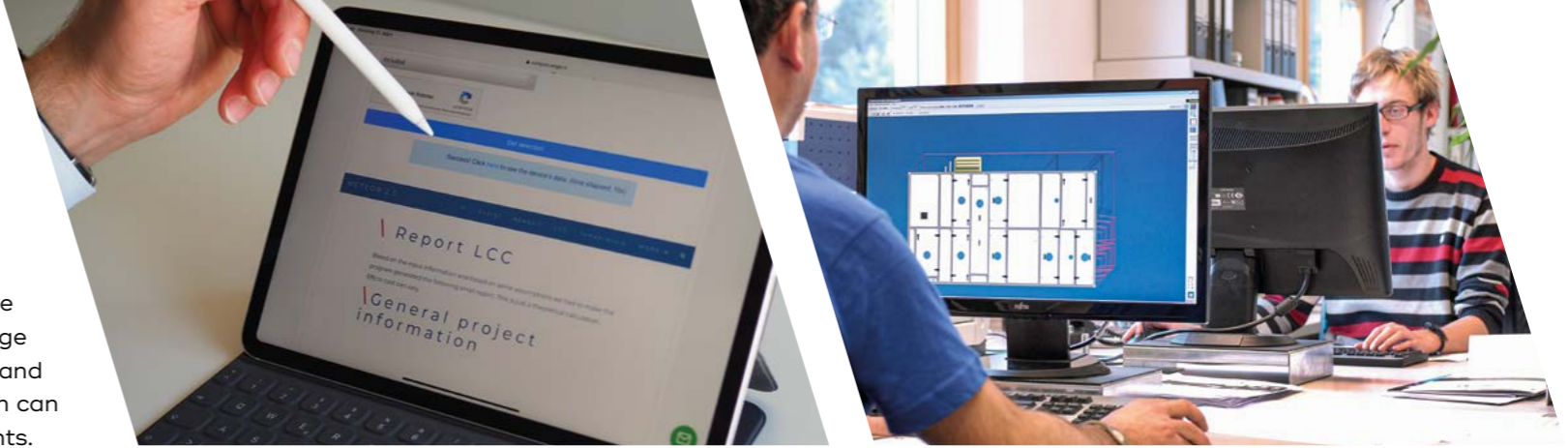

3 KV DESIGNER

The KV Designer is a software tool for the design of multi-function high-performance run around coil system. It supports the bundling of air flows from various applications, whereby the numbers of air inlet and outlets do not need to be identical, which demonstrates the capability of the software. In addition, there are many ways in which the calculations can be performed, be it on the basis of the size and number of the heat exchangers, specific performance targets or the envisaged efficiency. The CL Designer takes into account predefined air and mass flows that might vary between summer and winter, and considers the various country-specific standards as well as statutory regulations, such as EN 308 and the European Ecodesign Directive 1253/2014/EC governing energy-relevant products.

4 COMPASS

Compass is an advanced online tool for the preliminary selection and configuration of WEGER air handling units. Even if you did not yet have the time to evaluate and choose all possible features, Compass is able to select models that are likely to suit your requirements based on a few entered parameter values, as it works with artificial intelligence. Professionals can use the advanced functions of the program to dimension and design air handling units down to the last detail. The software provides you with a diagram of the configured system and a pdf document containing the technical data. The data can also be exported to a neutral IFC 4 interface. Should you encounter problems, use the chat function to discuss the issue with one of our specialist technicians. Alternatively, you can of course pick up the phone and call our hotline.

5 METEOR 2.0

Meteor is a tool for calculating the life cycle cost for a heat recovery system, taking into account weather and climate data. The online tool allows you to calculate the capital investment, the return of investment and the CO₂ emission reduction. It compiles statistics to determine cost savings as well as the life cycle costs (LCC) of a system. For an accurate simulation of the life cycle cost and the return on investment, the software requires of course realistic inputs of cost parameters such as investment costs and energy prices at the envisaged site of operation. The software comes with an intuitive interface and is easy to use. For professionals, there is the Expert mode for advanced calculations. In all cases, the quantity and quality of the data output depends of course on the quantity and quality of the data input. Nevertheless, operators can use the tool to compare the costs of different heat recovery systems for their centralised air handling units, so that they can make informed decisions regarding the next steps and the overall design of the system.

6 HPS SELECTOR

The HPS Selector is a user-friendly tool for the dimensioning of heat recovery hydraulic modules (HPS), which are indispensable in air handling units with high-performance run around coil systems. Based on a number of key parameters such as medium volume, expected performance and pressure loss, the HPS Selector identifies the most suitable assembly for a specific application. The HPS Selector does not only calculate the dimensions of the assembly, but also suggests recommended auxiliary components and optional equipment, such as for instance double pumps for enhanced operational safety. Apart from mechanical components, the HPS Selector also takes into account measuring and control hardware that might be useful. The software tool automatically generates an overview drawing, a technical data sheet, tender specifications and a detailed price calculation.

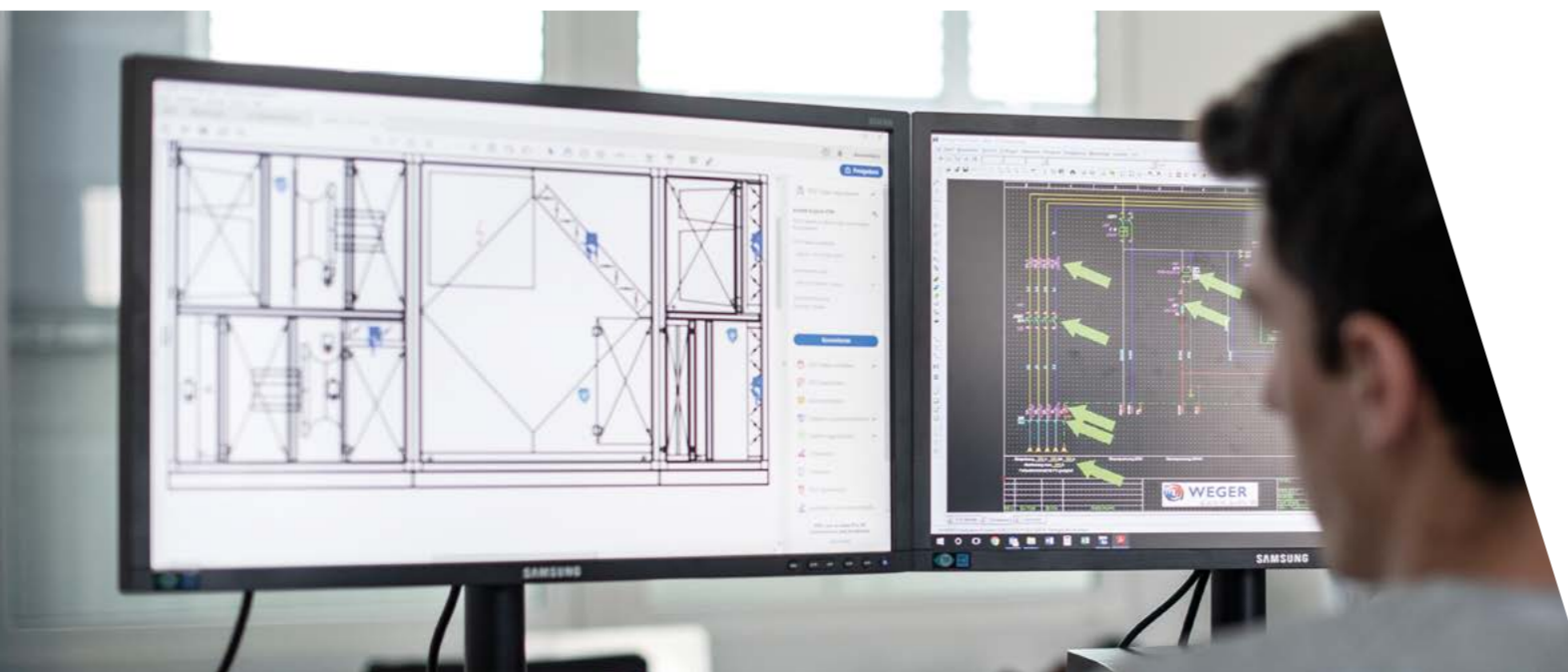

Mollier h-x diagram

Air pressure 1.013 mbar, altitude 0 m above sea level

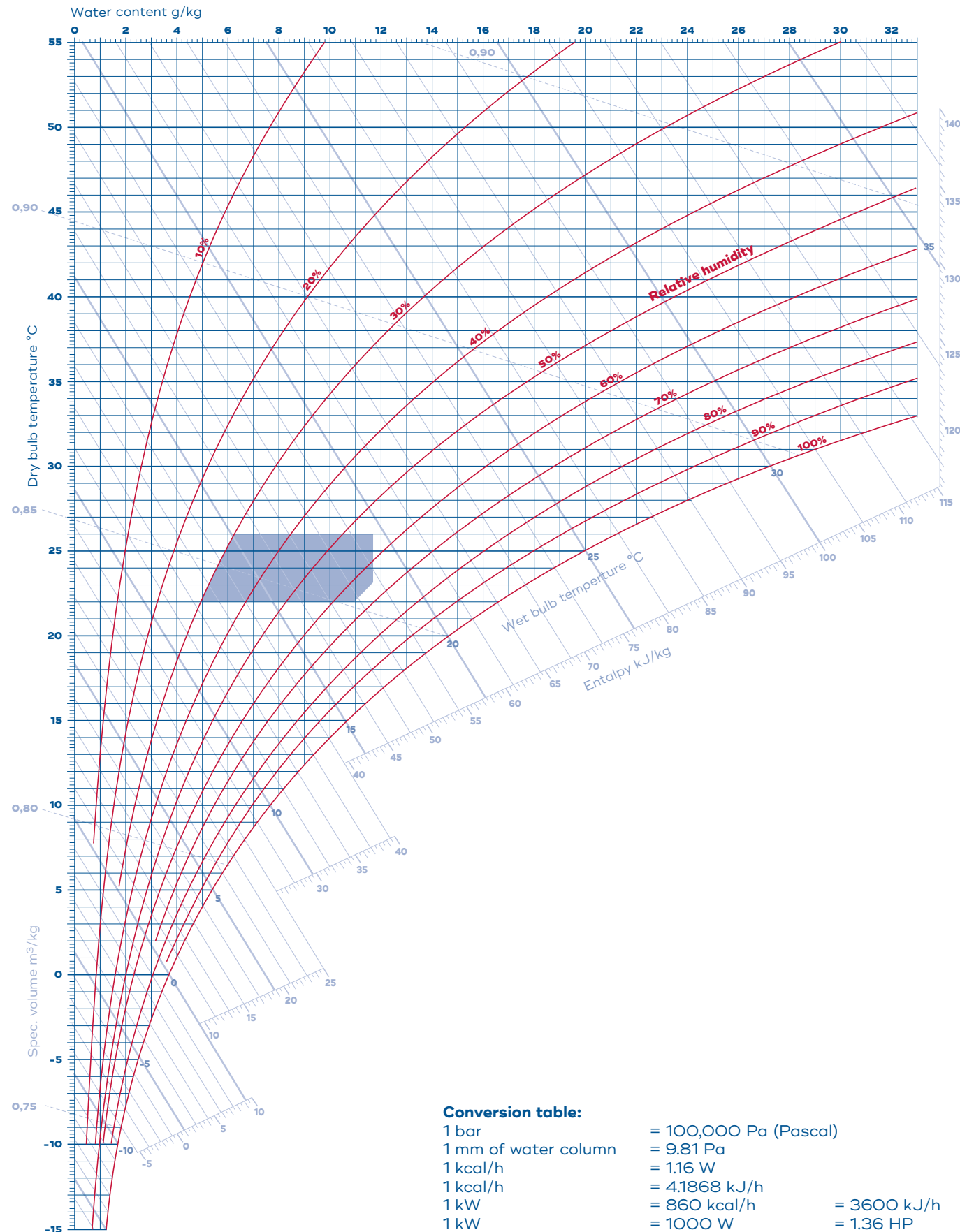

Transport & lifting devices

The WEGER units are placed on pallets (height 180 mm) or on a base frame (height 120 mm) for delivery by HGV. The actual load must be 300 mm smaller than the vehicle's cargo space height. In order to avoid additional costs for special transports, we always try to keep the overall height of our units below 2.6 m. On request, we offer of course larger unit sizes, and are experienced in special logistics. On site, the unit can be unloaded by lift truck, fork-lift truck or crane.

When using a forklift truck, make sure that the base frame of the unit is fully resting on the lift arms, and

that the centre of gravity is positioned between the arms so that the forces act on the base frame profiles. The profiles must not be damaged. Do not climb onto the unit and never lift it by protruding parts such as connectors.

For transport and unloading by crane, use suitable and approved attachment devices. Install spacers as necessary to prevent damage to the unit. Attach the crane hooks to the crane lugs provided. Never attach the lifting tackle to the upper corner connections. Should the unit not feature any crane lugs, it must be lifted with straps.

TRANSPORT OPTIONS / AVAILABLE CARGO SPACE:

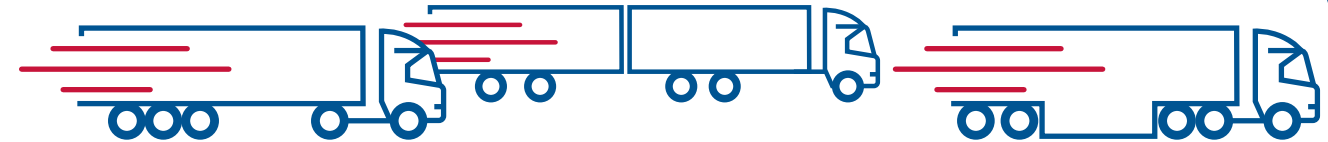

MEGA TRAILER
Length: 13.60 m
Width: 2.45 m
Height: 2.6-3.0 m
Max. load: 25 t

JUMBO TRAILER
Length: 7.7+7.7 / 6.4+9 m
Width: 2.45 m
Height: 2.8-3.2 m
Max. load: 25 t

LOW-BED TRAILER
Length: 6.9+6.6 / 9.9+4 m
Width: 2.45 m
Height: 3.2-3.9 m
Max. load: 25 t

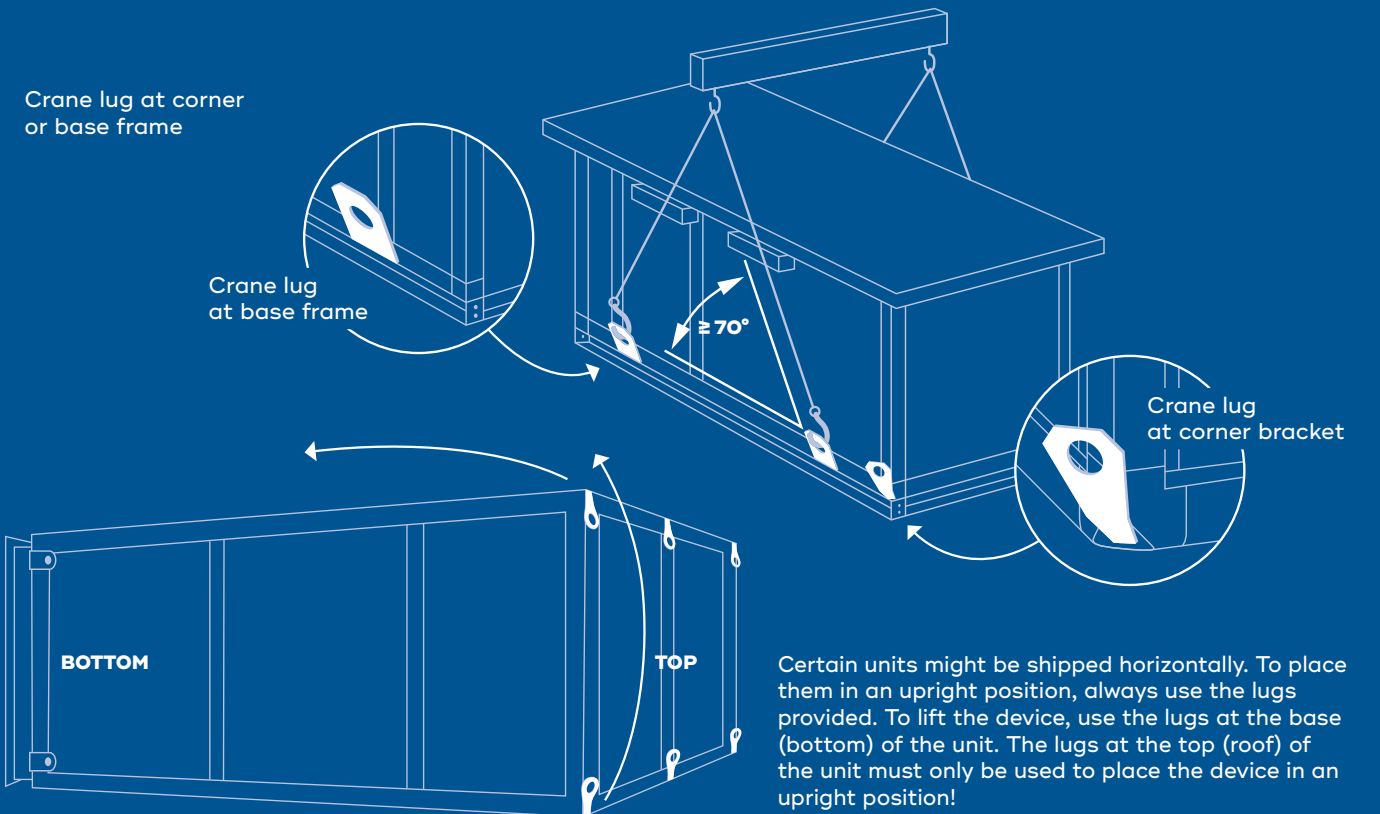

Air for life. Climate for well-being.
What we produce meets essential human needs. That drives us to do our best.
System solutions for ventilation and air conditioning that inspire thanks to cutting-edge technology, reliability and sustainability. Worldwide.

Weger Walter GmbH
Handwerkerzone 5
I-39030 Kiens/Ehrenburg (BZ)

T. +39 0474 565 253
F. +39 0474 565 011
info@weger.it
www.weger.it

A company from
SÜDTIROL

 **WEGER**
quality air, quality life